

# Triumph Play Systems



## Festival Ten Assembly Directions

**Required Tools List**

	Cordless Drill
	#8 Countersink Drill Bit with Pilot Bit
	Socket Wrench or Socket Adapter
	9/16" Socket (Long shank/deep style)
	1/2" Socket
	7/16" Socket
	#2 Square Head Driver Bit
	2-Foot Level
	Tape Measure
	6" Drill Bit Extension or 6" #2 Square Head Driver Bit
	3/8" Drill Bit

**Suggested Optional Tools**

	Cordless Impact Wrench/Driver

Leave 6' For Safe Exit

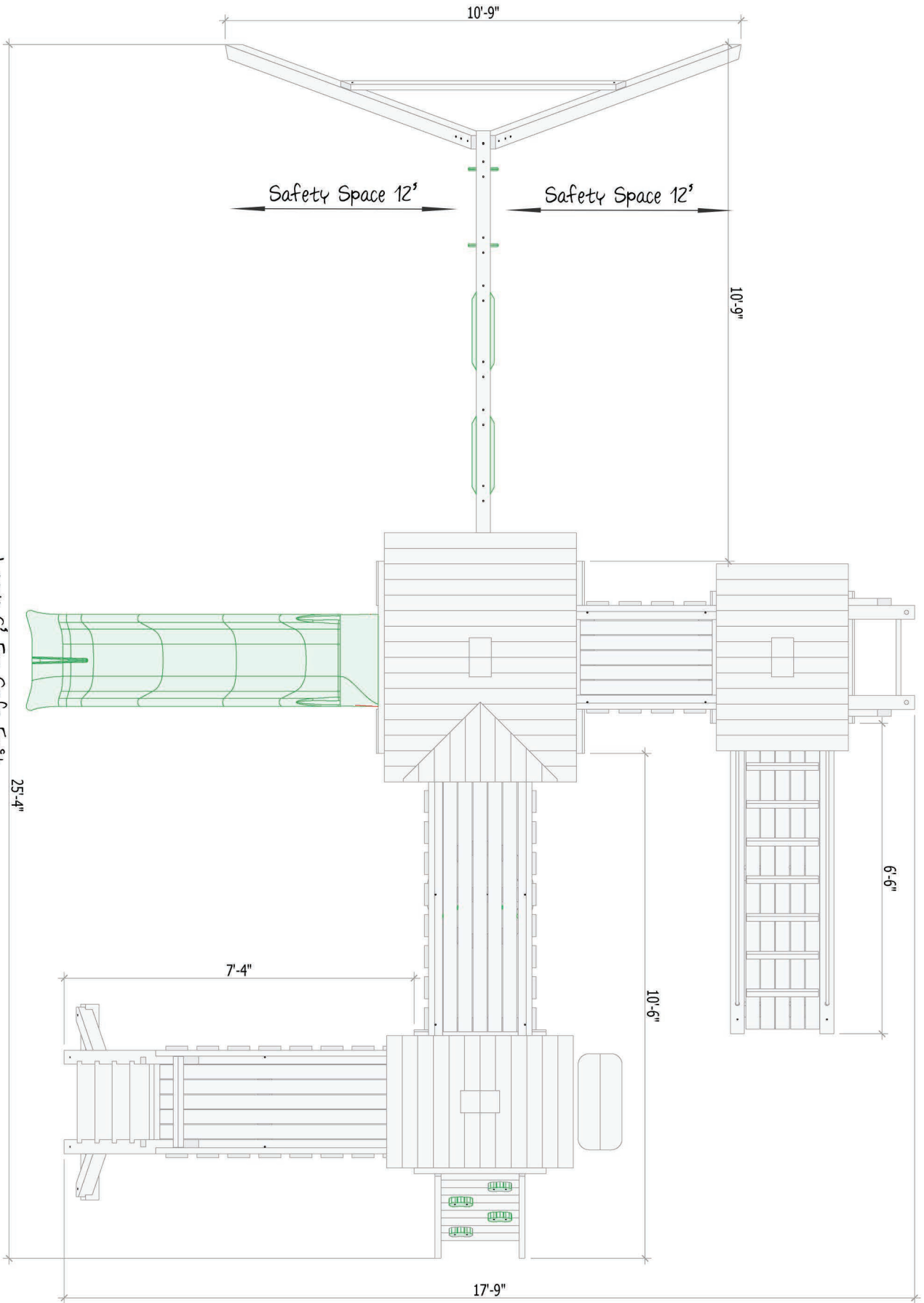

# Festival Ten

Triumph Play Systems  
15 Maple Ave  
Ashburnham, MA



## Step One: Side Wall Assemblies

1.1 With a hammer, insert T-Nuts into Corner Post - L (2) and Corner Post - R (2) as shown in Figure 1.3. Note direction of the Lap Joints at the top of the posts.

1.2 Fasten Top Support 48" (2) to the bottom of Corner post with 5/16 x 4-1/2 Hex Bolts with 5/16 washer as shown in Figure 1.1 and 1.2. Tighten until T-Nuts are flush with surface.

1.4 Fasten Top Support 12" (2) to Corner Post with 5/16 x 4-1/2 Hex Bolts with 5/16 washer as shown in Figure 1.1. Tighten until T-Nuts are flush with surface.

1.5 Fasten Swing Beam Support to Corner Post with 5/16 x 6 Hex Bolts with 5/16 washer as shown in Figure 1.2. Make sure the Countersink Hole in center is facing down.

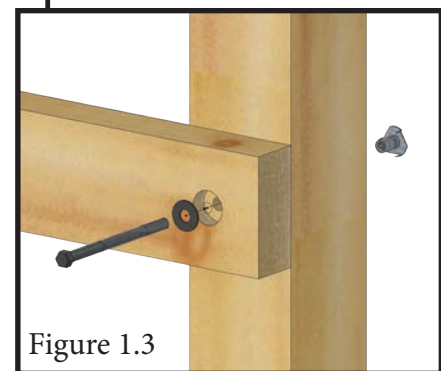
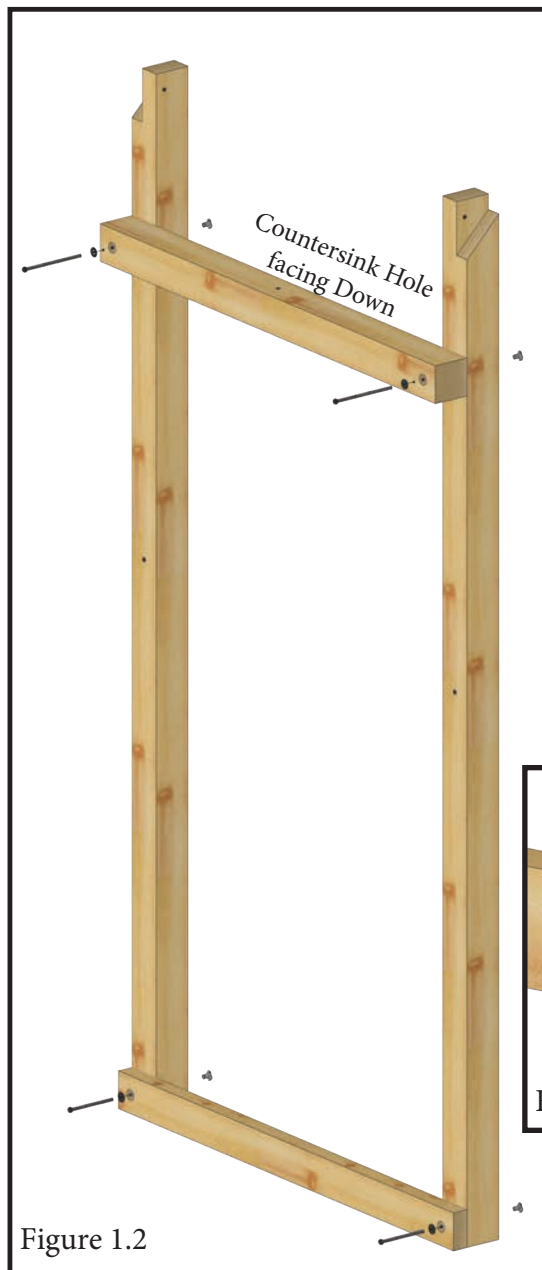
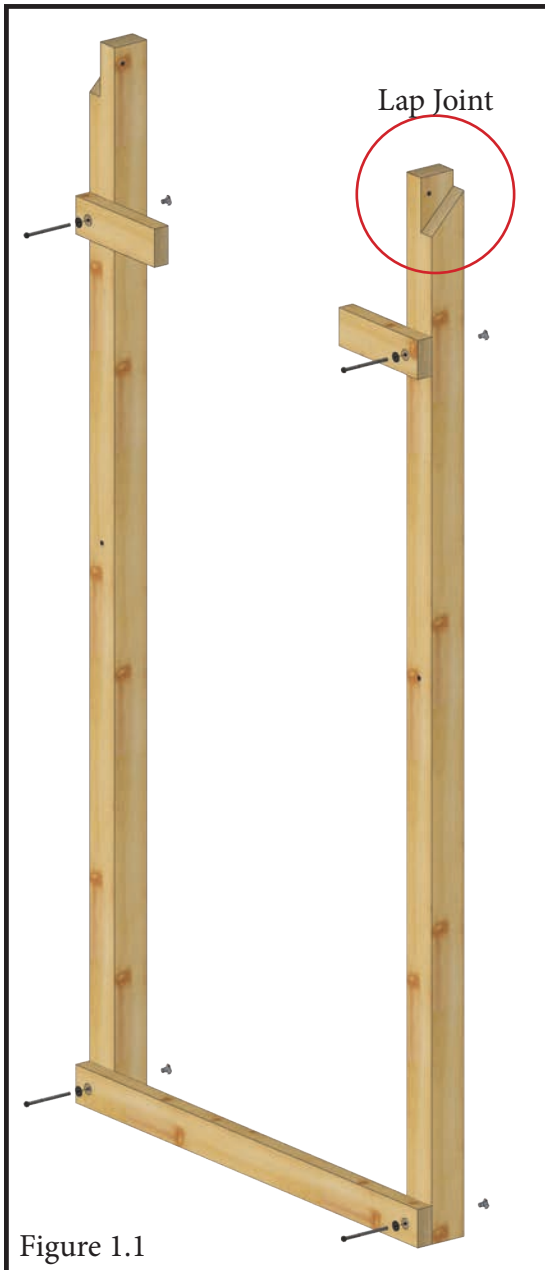

## Step Two: Deck Supports

2.1 With a hammer, insert T-Nuts into the outside of Corner Post - L and Corner Post - R as shown in Figure 2.1.

2.2 Fasten Deck Support to Corner Post with 5/16 x 6 Hex Bolts with 5/16 washer. Tighten until T-nuts are flush with surface.

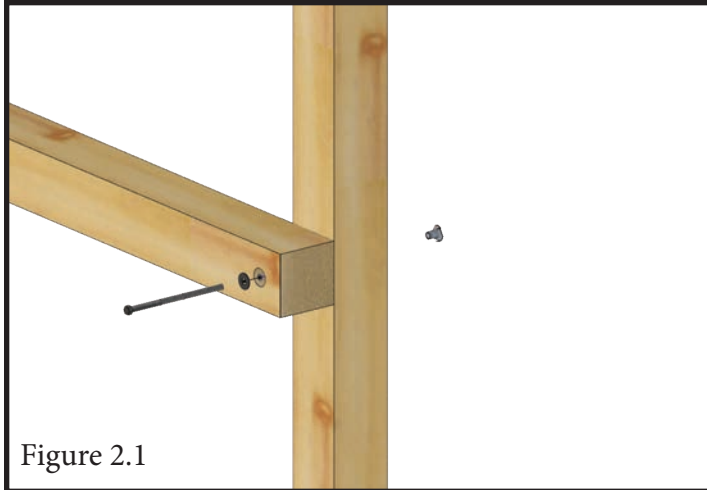

2.3 Pre-drill and Fasten Deck Boards 41" to Deck Supports with #8x2-1/2 Screws (4 each) as shown in Figure 2.3.

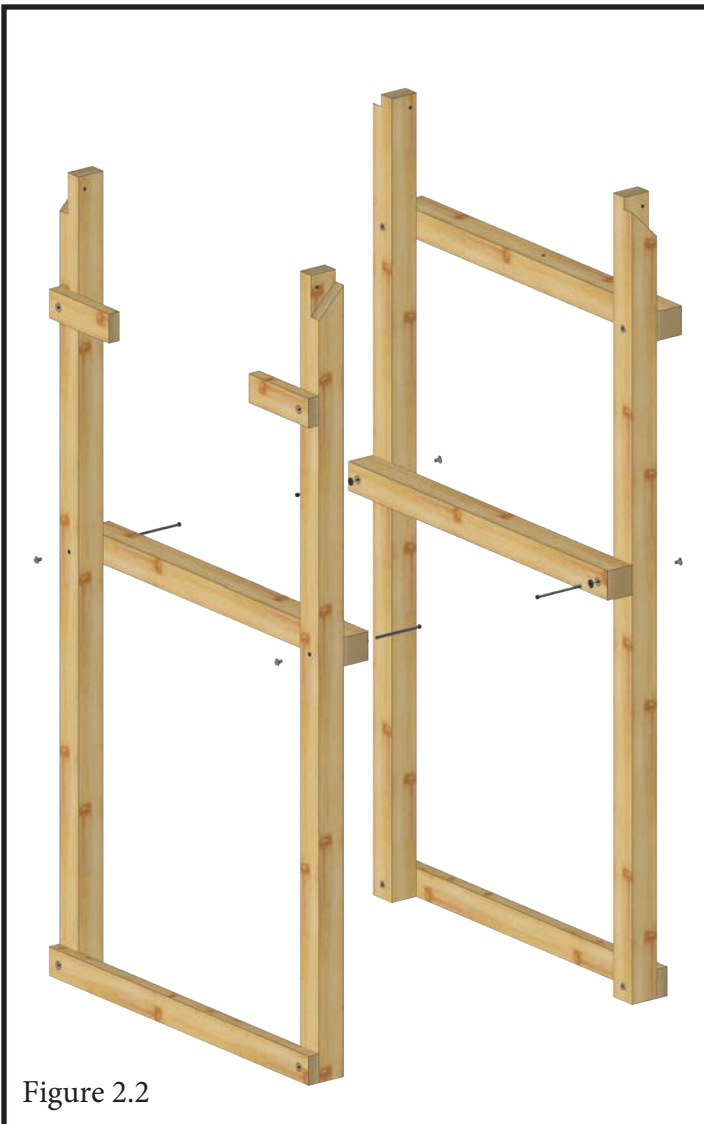

### Step Three:

3.1 Fasten Top Panel Offset 48" (3) to Corner Post with 5/16 x 3 Lag Bolt with 5/16 washer as shown in Figure 3.1. Drive lags until washer starts to "sink" into wood.

3.2 Fasten Top Panel Offset 12" (2) to Corner Post with 5/16 x 3 Lag Bolt with 5/16 washer as shown in Figure 3.1. Drive lags until washer starts to "sink" into wood.

3.3 Place the tower in desired location. Check for square, level under the frame and check the posts for plumb.

3.4 Fasten Slim Sams (4) to Corner Posts and Deck Supports with 5/16 x 3 Lag Bolts with 5/16 washer as shown in Figure 3.2.



Figure 3.1

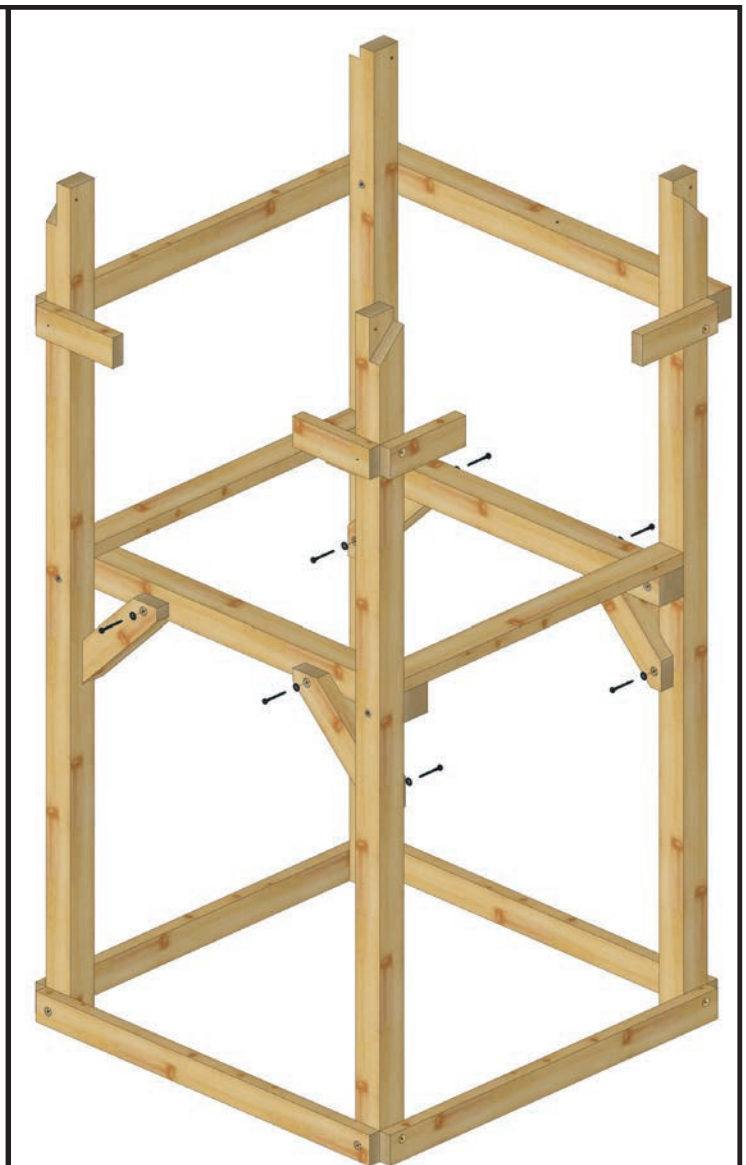

Figure 3.2

## Step Four: Lower Walls

4.1 Measure up from ground 22-1/2 inches and mark the corner posts.

4.2 Fasten Top Panel Offset 48" (3) to Corner Post with 5/16 x 3 Lag Bolts with 5/16 washer as shown in Figure 4.0. Be sure to flip the orientation as you go to avoid the lags colliding in each corner post.

4.3 Fasten Top Support 12" to Corner Post with 5/16 x 3 Lag Bolts with 5/16 washer as shown in Figure 4.0.

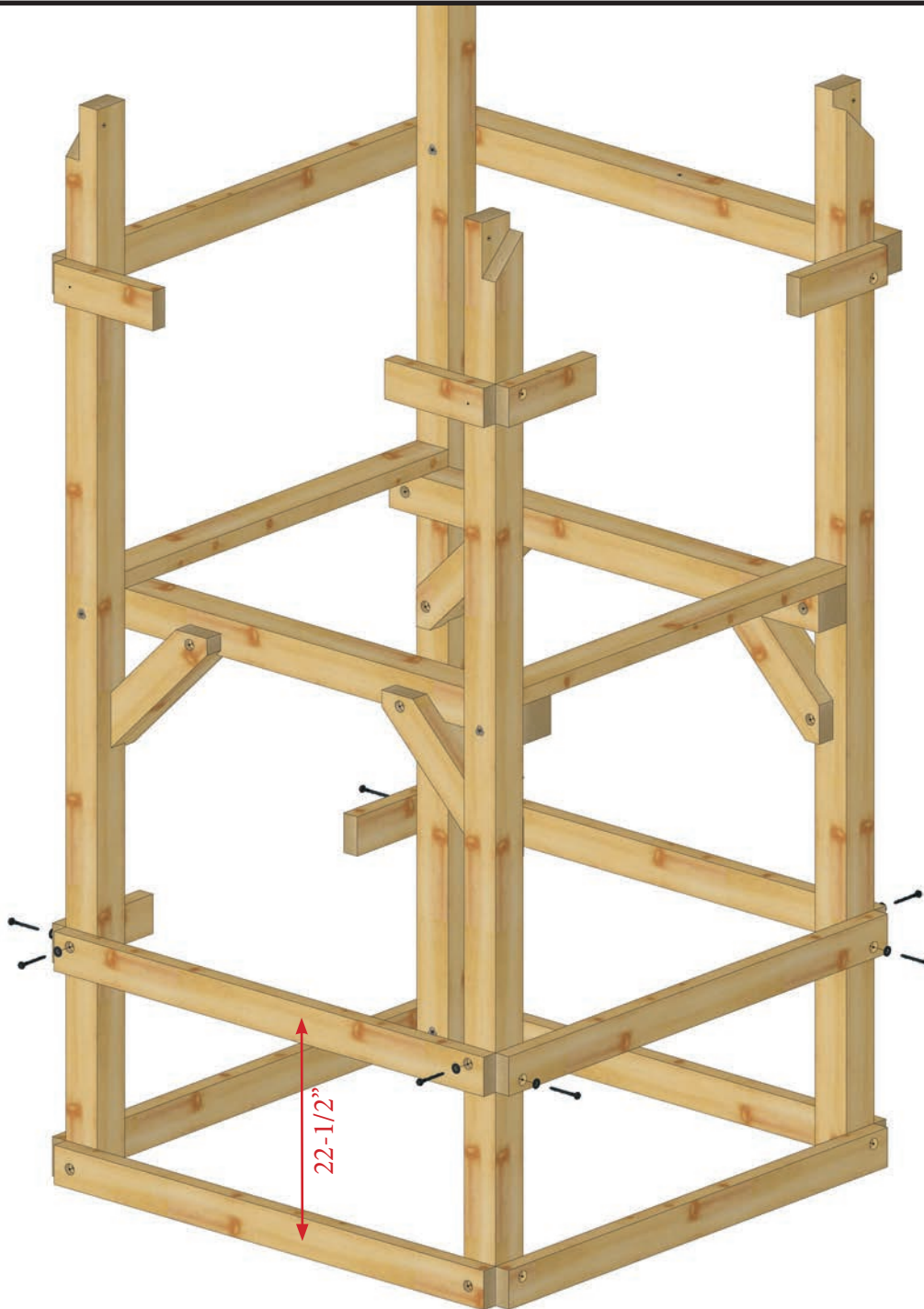

Figure 4.0

## Step Five: Lower Wall Slats

5.1 Pre-drill and fasten Slat 22.5 to Top Panels with #8x2 screws as shown in Figure 5.0. (Spacing between slats is about 2-1/4")

5.2 Pre-drill and fasten Counter 48" to Top Panels with #8x2 screws as shown in Figure 5.1.

5.3 Pre-drill and fasten Counter 12" to Top Panel 12" with #8x2 screws as shown in Figure 5.1.



Figure 5.0

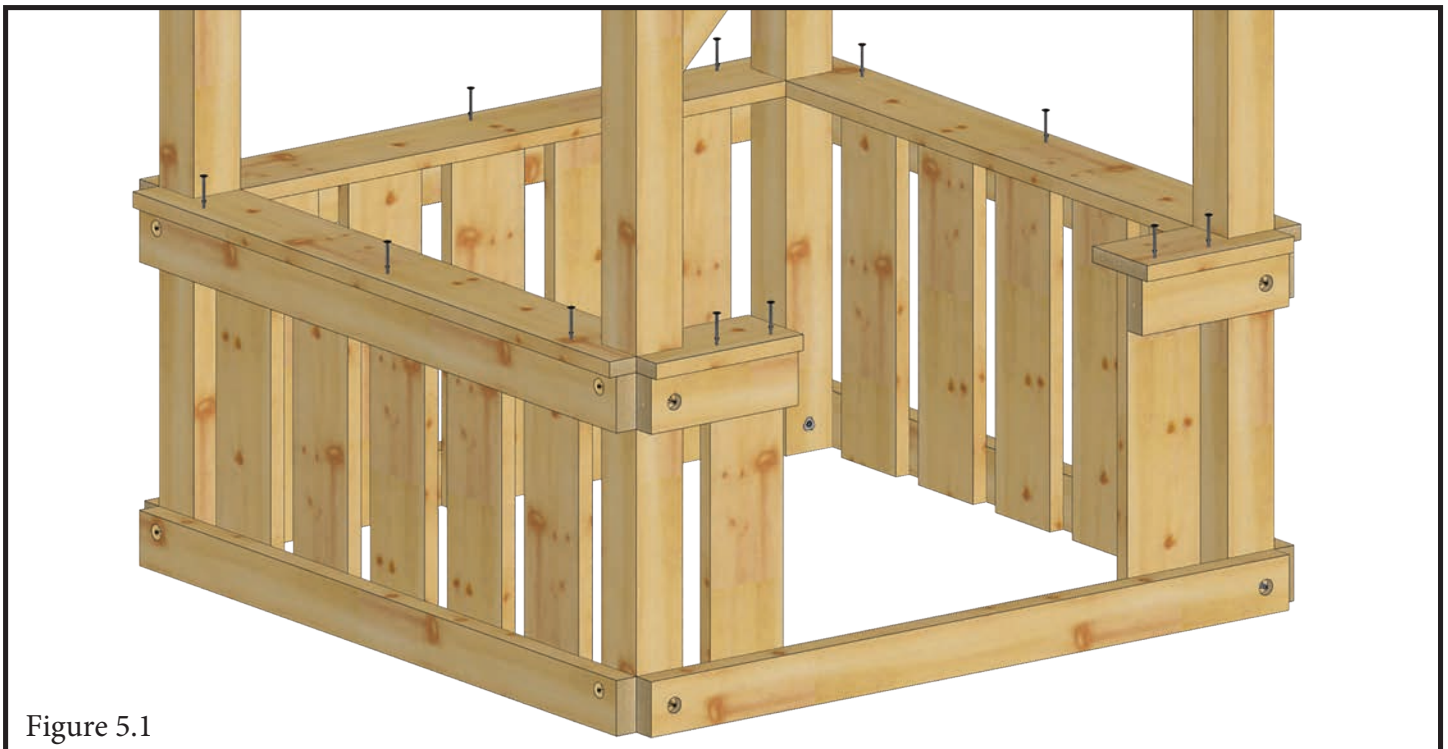

Figure 5.1



## Step Six: Deck Boards

6.1 Pre-drill and evenly space out deck board 48".

6.2 Fasten Deck Boards 48" to Deck Supports with #8x2-1/2" screws (4 each) as shown in Figure 6.1.

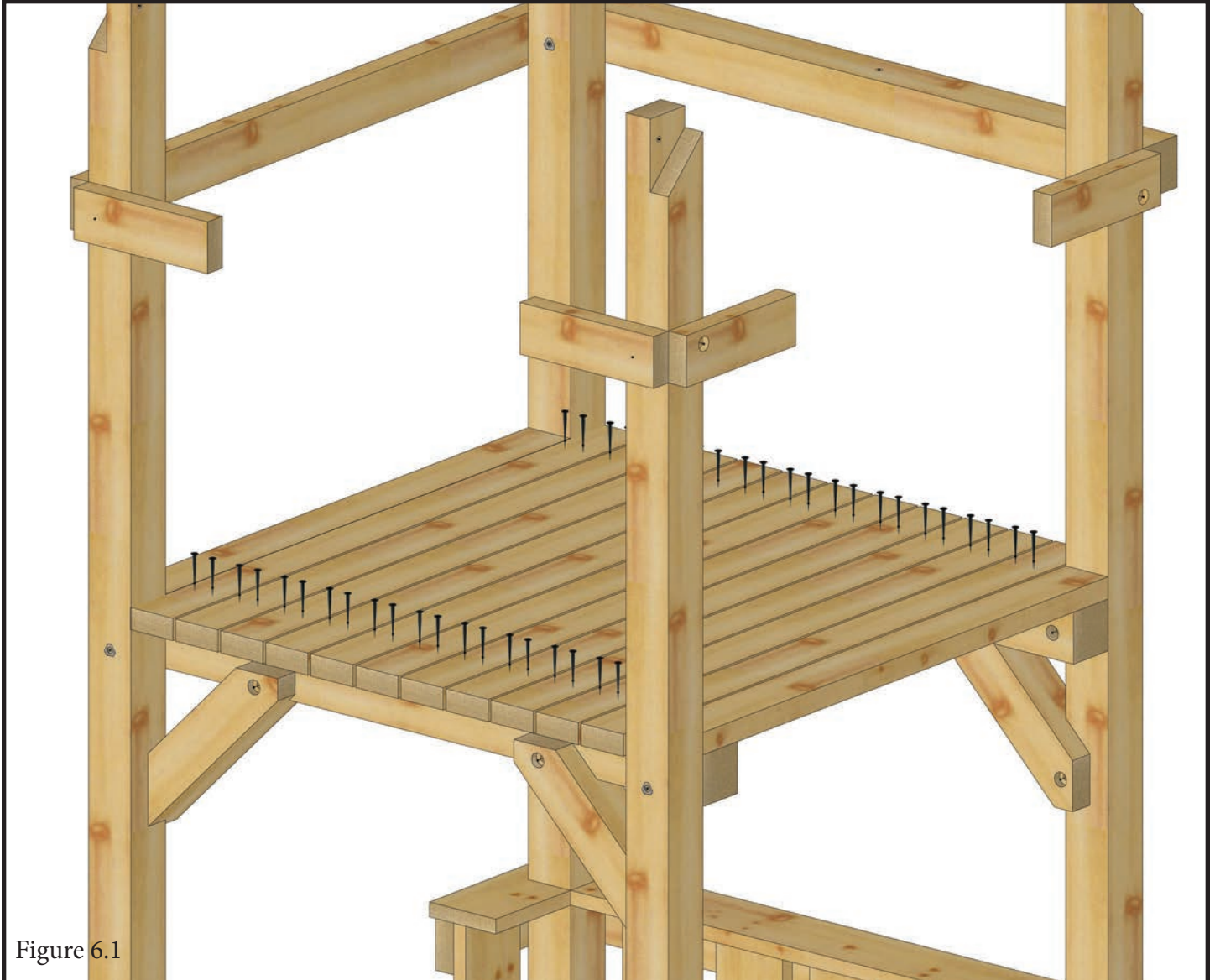

Figure 6.0 Shows how to use the screws for spreading out deck boards with even spacing.

## Step Seven: Fascia Boards

7.1 Fasten Fascia (3) to Corner Post with 1/4 x 2-1/2 Lag Bolts with 1/4 washer as shown in Figure 7.0.

7.2 Fasten Fascia Mount (1) to Corner Post with 1/4 x 2-1/2 Lag Bolts with 1/4 washer as shown in Figure 7.0. Mind the offset pattern as shown in Figure 7.1. The Fascia Mount will accept the ladder and can go on either the front or the back.

Figure 8.0

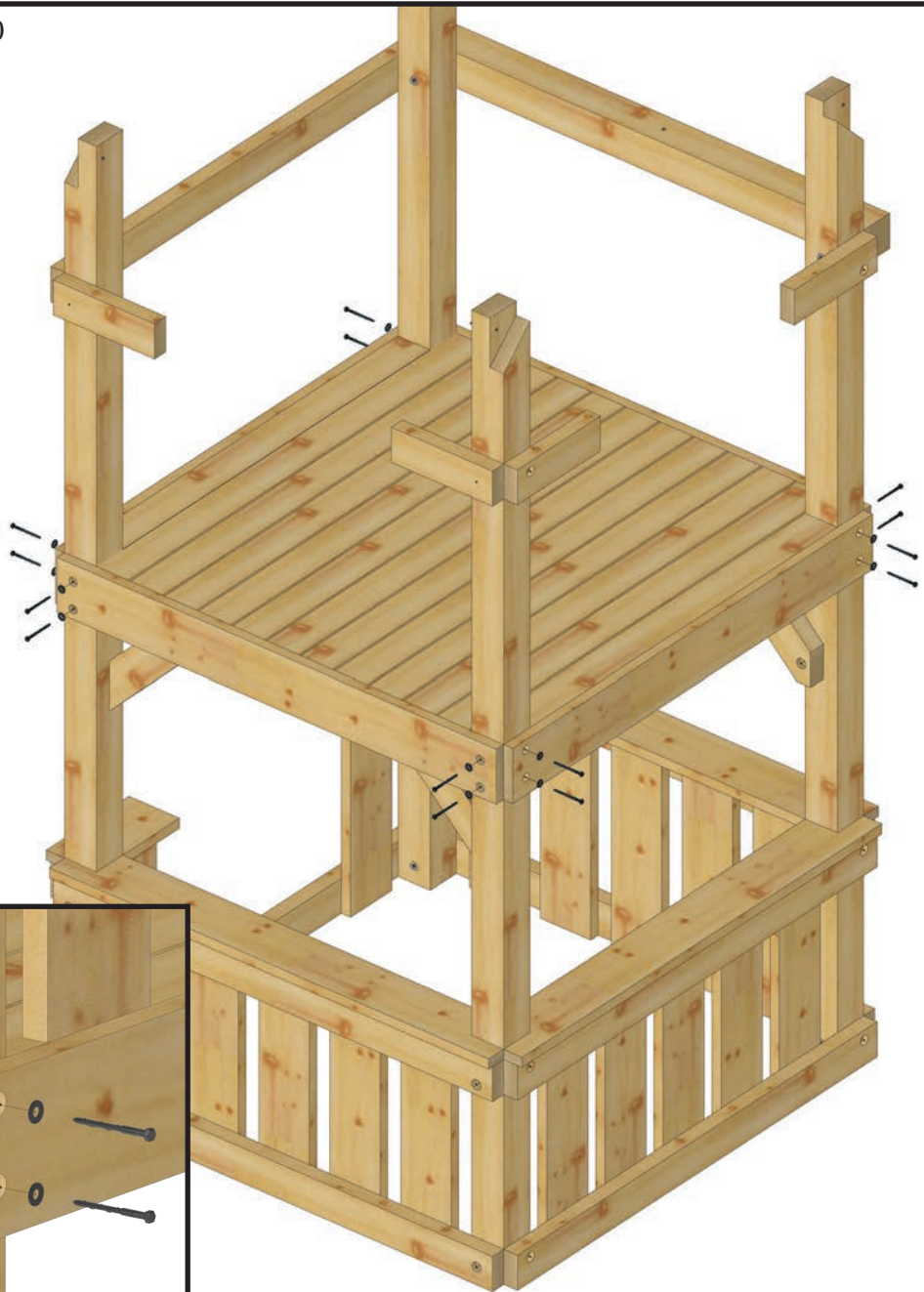
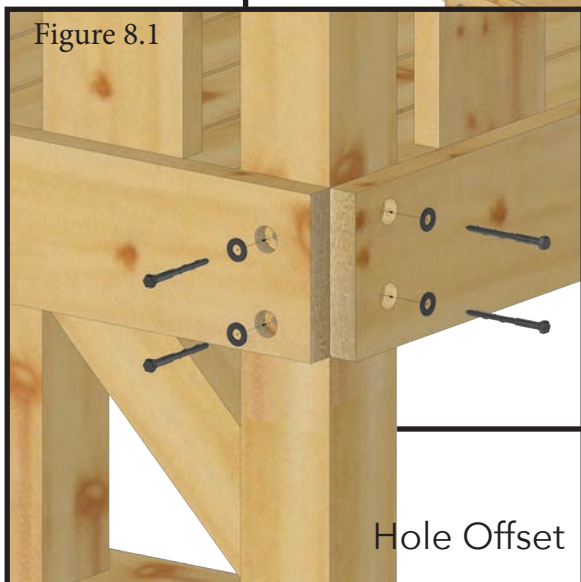

Figure 8.1



Hole Offset

## Step Eight: Tower Side Wall Assembly

8.1 With a hammer, insert T-Nuts into Corner Post - L and Corner Post - R as shown in Figure 8.1 and 8.2. Note direction of the Lap Joints at the top of the posts.

8.2 Fasten Top Support 33" (3) to top and bottom of Corner post with 5/16 x 4-1/2 Hex Bolts with 5/16 washer as shown in Figure 8.1. Tighten until T-Nuts are flush with surface.

8.3 Fasten Deck Support 33" (2) to Corner Post with 5/16 x 6 Hex Bolts with 5/16 washer.

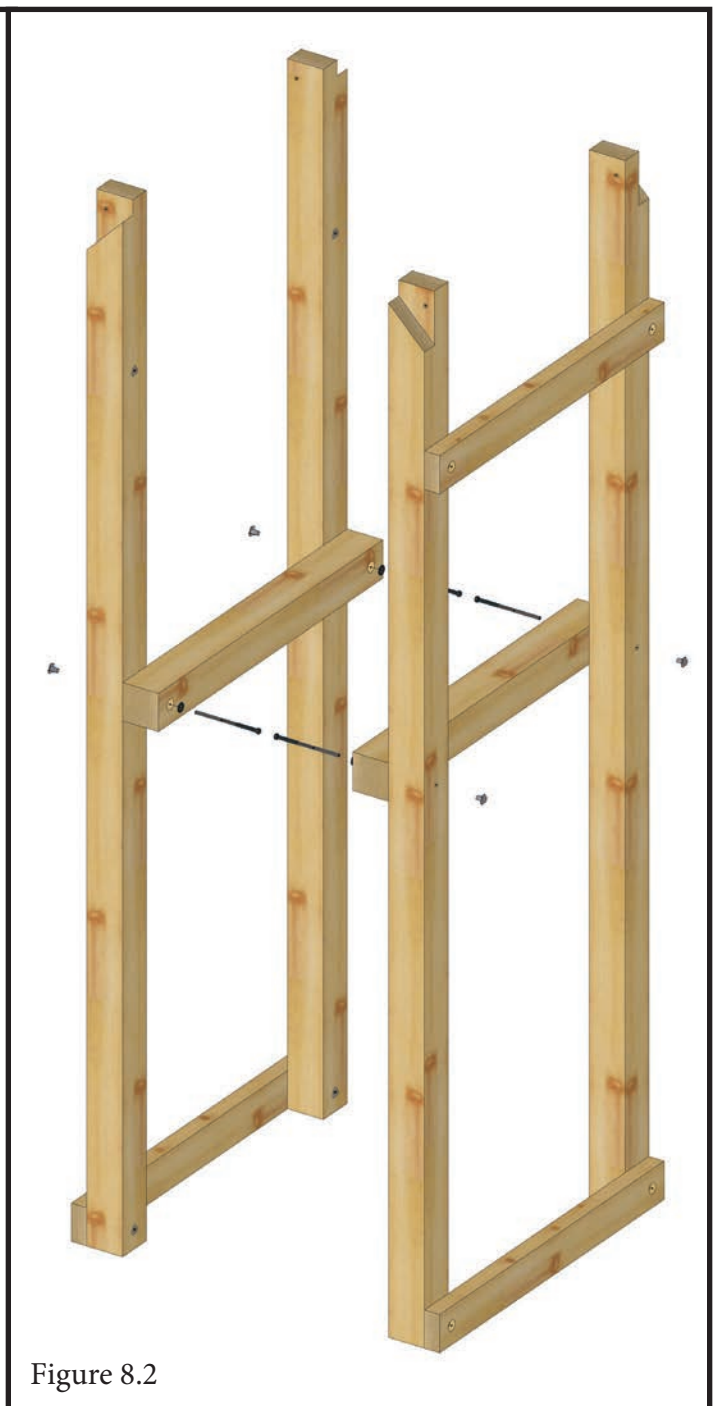
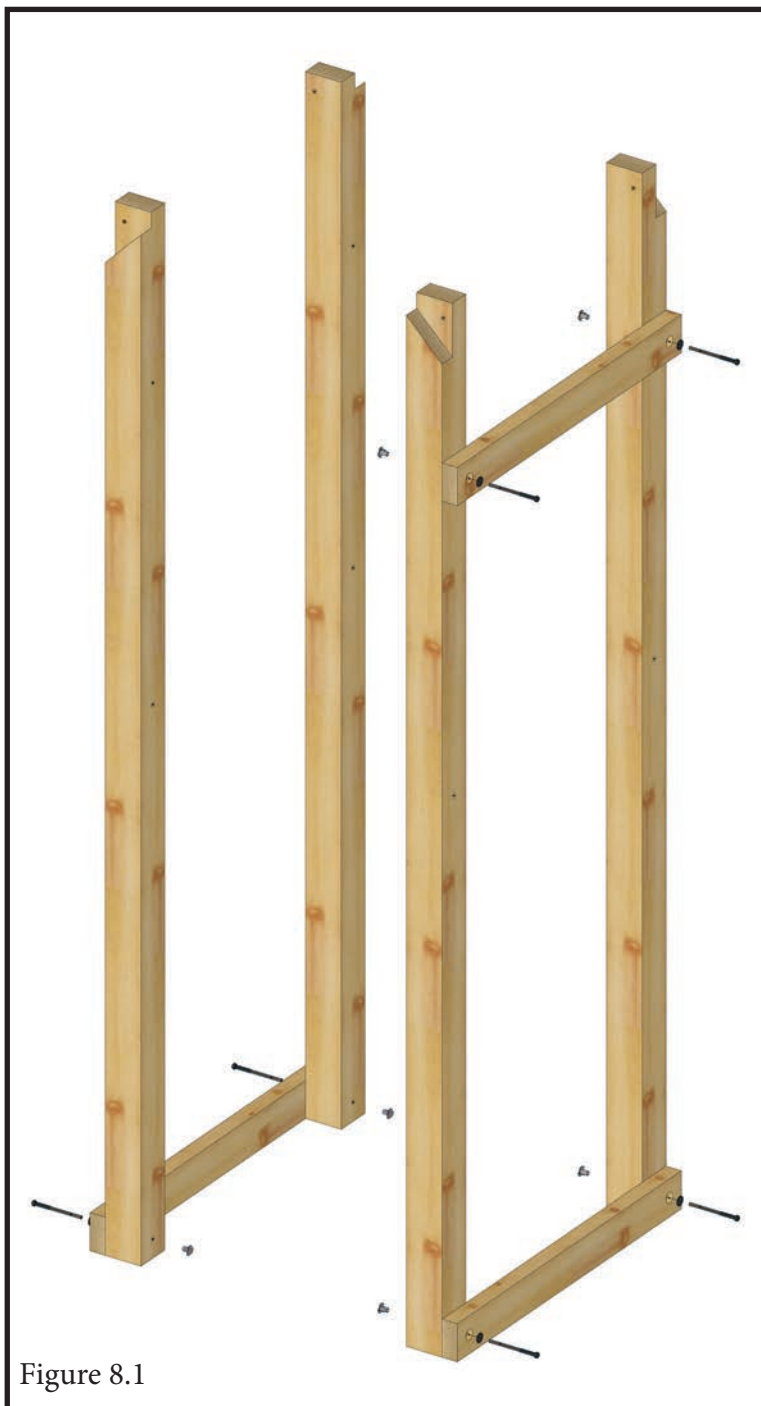

## Step Nine: Tower Assembly

9.1 Pre-drill and Fasten Deck Boards 26" (2) to Deck Supports with #8x2-1/2 Screws (4 each) as shown in Figure 9.1.

9.2 Fasten Top Panel Offset 33" (3) to Corner Post with 5/16 x 3 Lag Bolts with 5/16 washer. Drive lags until washer starts to "sink" into wood.

9.3 Place the towers in desired location. Check for square, level under the frame and check the posts for plumb.

9.4 Fasten Slim Sams (4) to Corner Posts and Deck Supports with 5/16 x 3 Lag Bolts with 5/16 washer as shown in Figure 9.2.



Figure 9.1

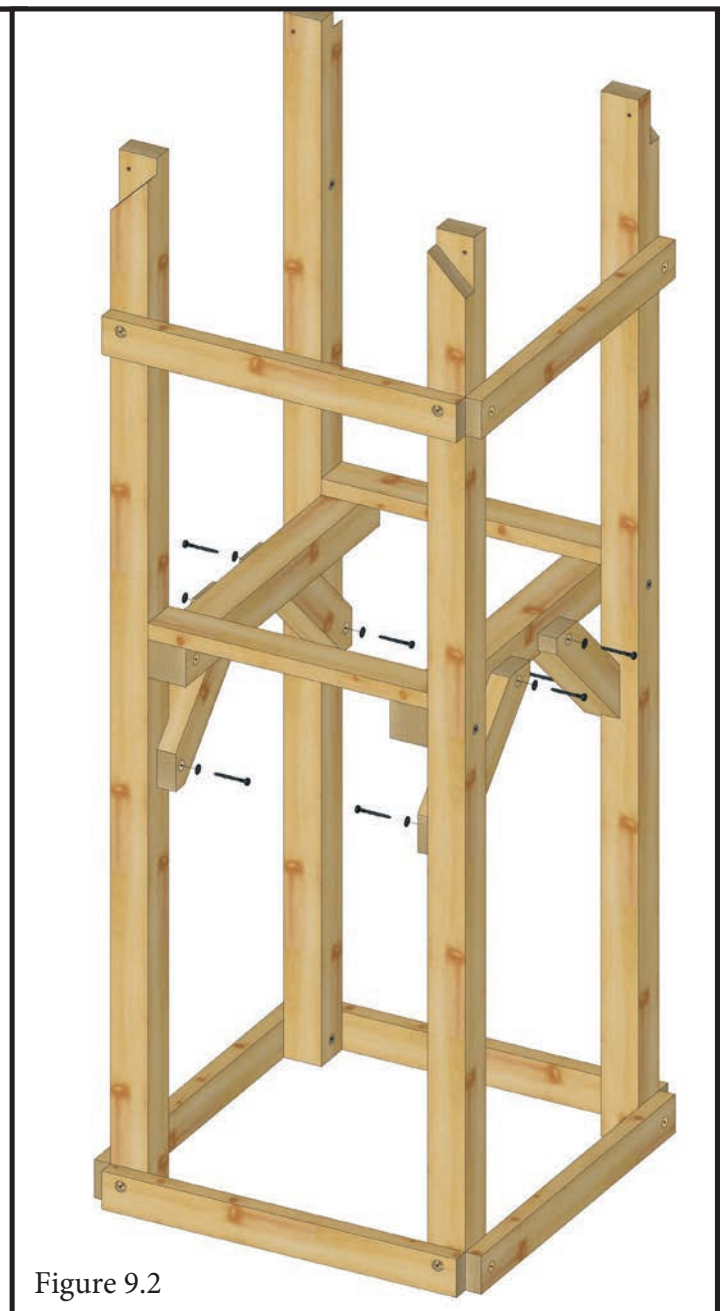

Figure 9.2

## Step Ten: Deck Boards & Fascia Boards

10.1 Pre-drill and evenly space out Deck Boards 33" as shown in Figure 10.1.

10.2 Fasten Fascia 33" (3) to Corner Post with 1/4 x 2-1/2 Lag Bolts with 1/4 washer as shown in Figure 10.2. Mind the offset pattern.

10.2 Fasten Fascia 33" Mount (1) to Corner Post with 1/4 x 2-1/2 Lag Bolts with 1/4 washer as shown in Figure 10.2.



Figure 10.1

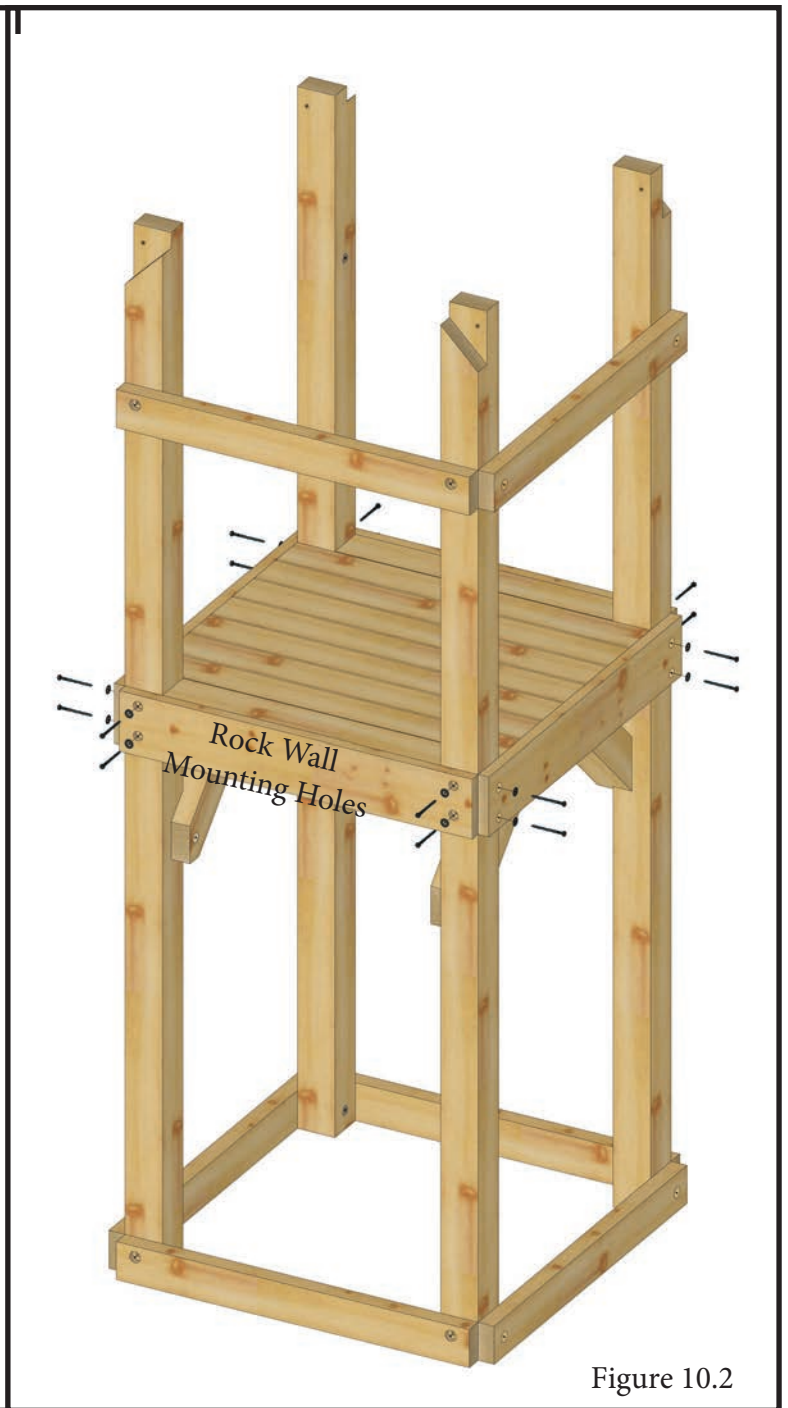

Figure 10.2

## Step Eleven : Long Bridge Pre-assembly

11.1 Fasten GW Deck Supports (2) to Bridge Supports with 5/16 x 4-1/2 Hex Bolts and 5/16 washer into T-Nut as shown in Figure 11.1.

11.2 Fasten GW Tire Support to Bridge Supports with 5/16 x 4-1/2 Hex Bolts and 5/16 washer into T-Nut as shown in Figure 11.1.

11.3 Fasten Tire Swivel to GW Tire Support with 5/16 x 1-3/4 Hex Bolts and 5/16 washer into T-Nut as shown in Figure 11.1. Snap spring clip.

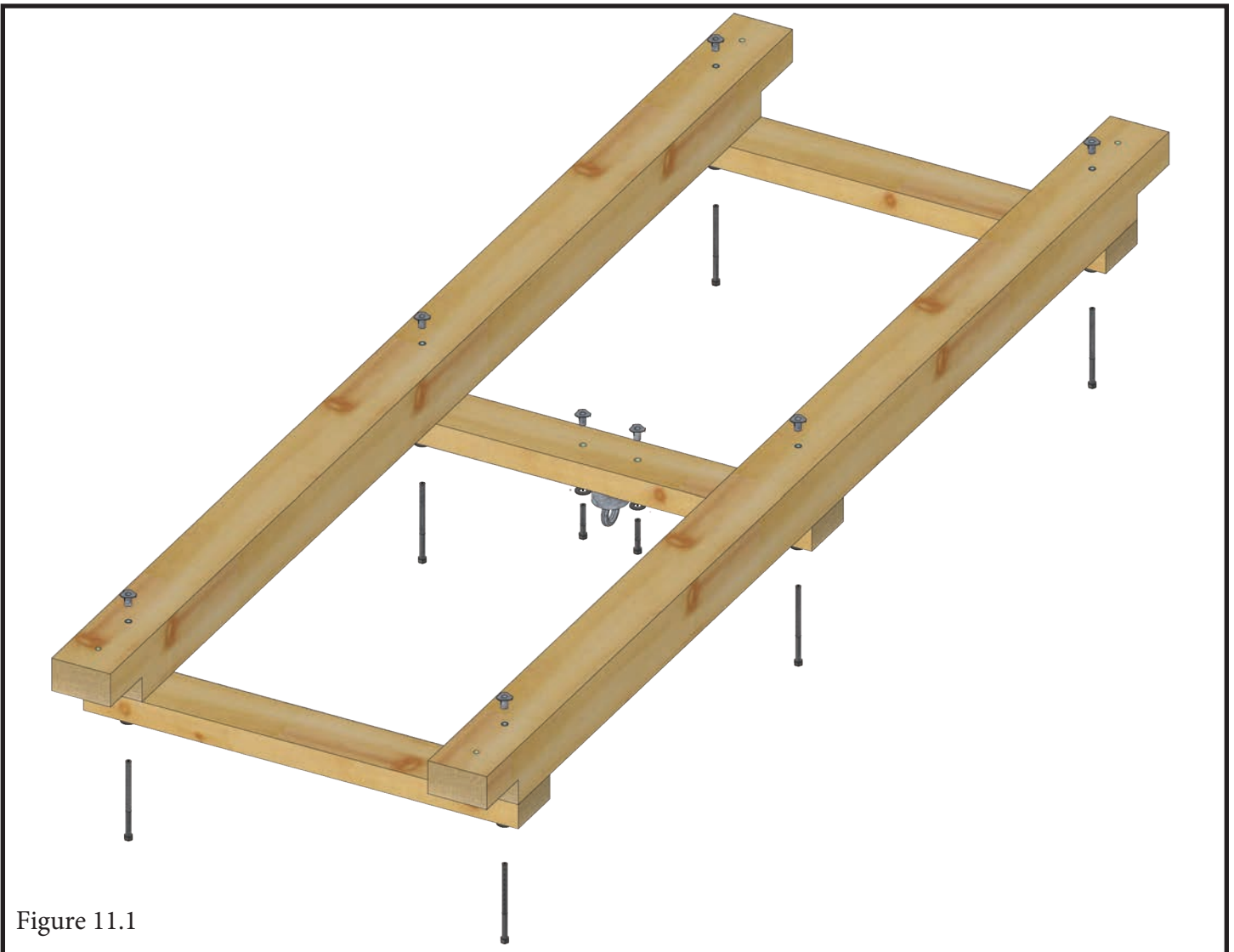

## Step Twelve: Bridge attachment

12.1 Fasten Bridge Assembly down into deck of both towers with 5/16 x 3 Lag Bolts with 5/16 washer. Note: The Towers need to be level with each other. Level Small Tower as needed.

12.2 Pre-drill and Fasten Bridge Rails to Top Support 12" with #8x2-1/2" screws as shown in Figure 12.1.

12.3 Fasten Bridge Rails to the Tower Posts with 5/16 x 3 Lag Bolts with 5/16 washer. Make sure the Rails are level with the Bridge Supports on both ends.



Figure 12.1

### Step Thirteen: Bridge (continued)

13.1 Pre-drill and fasten Bridge Deck Boards down with 2-1/2" Screws as shown in Figure 13.1.

13.2 With roughly 2-1/4" spacing between slats, fasten the Pocket Slat 29.5" Boards down to the tower decks with 2" Screws as done in Step 7 and shown in Figure 13.2.

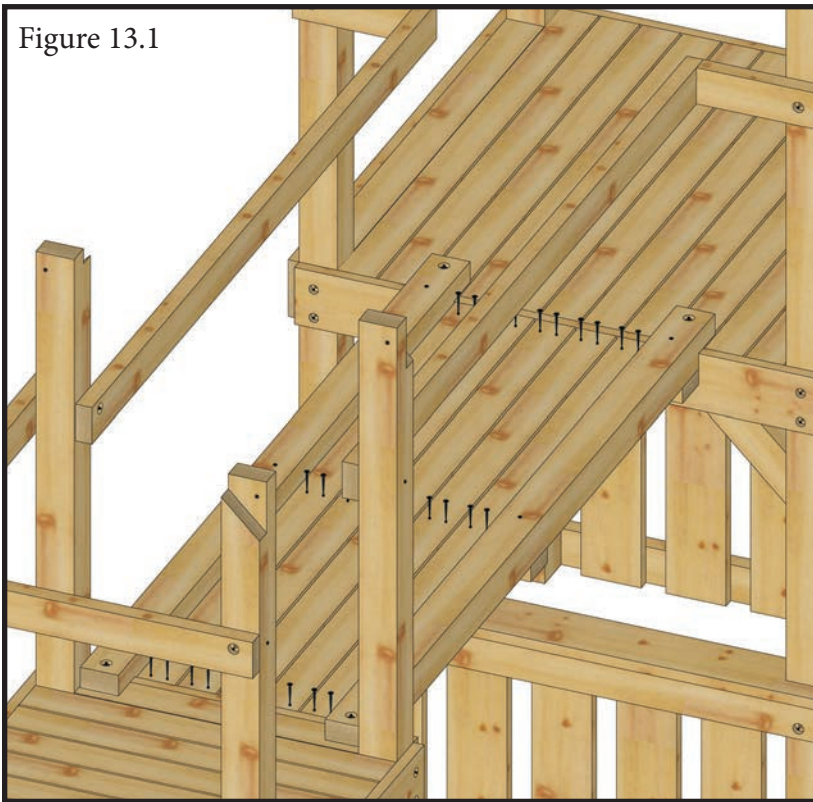

Figure 13.1

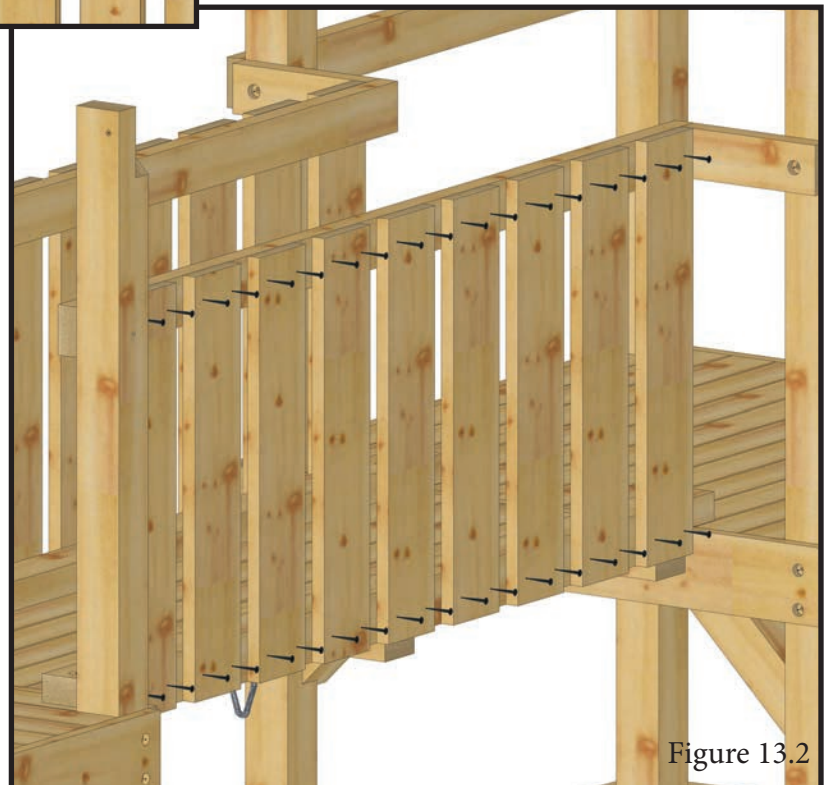

Figure 13.2



## Step Fourteen: Tower Side Wall Assembly

14.1 With a hammer, insert T-Nuts into Corner Post - L and Corner Post - R as shown in Figure 14.1 and 14.2. Note direction of the Lap Joints at the top of the posts.

14.2 Fasten Top Support 33" to top and bottom of Corner post with 5/16 x 4-1/2 Hex Bolts with 5/16 washer as shown in Figure 14.1. Tighten until T-Nuts are flush with surface.

14.3 Fasten Deck Support 33" to Corner Post with 5/16 x 6 Hex Bolts with 5/16 washer.

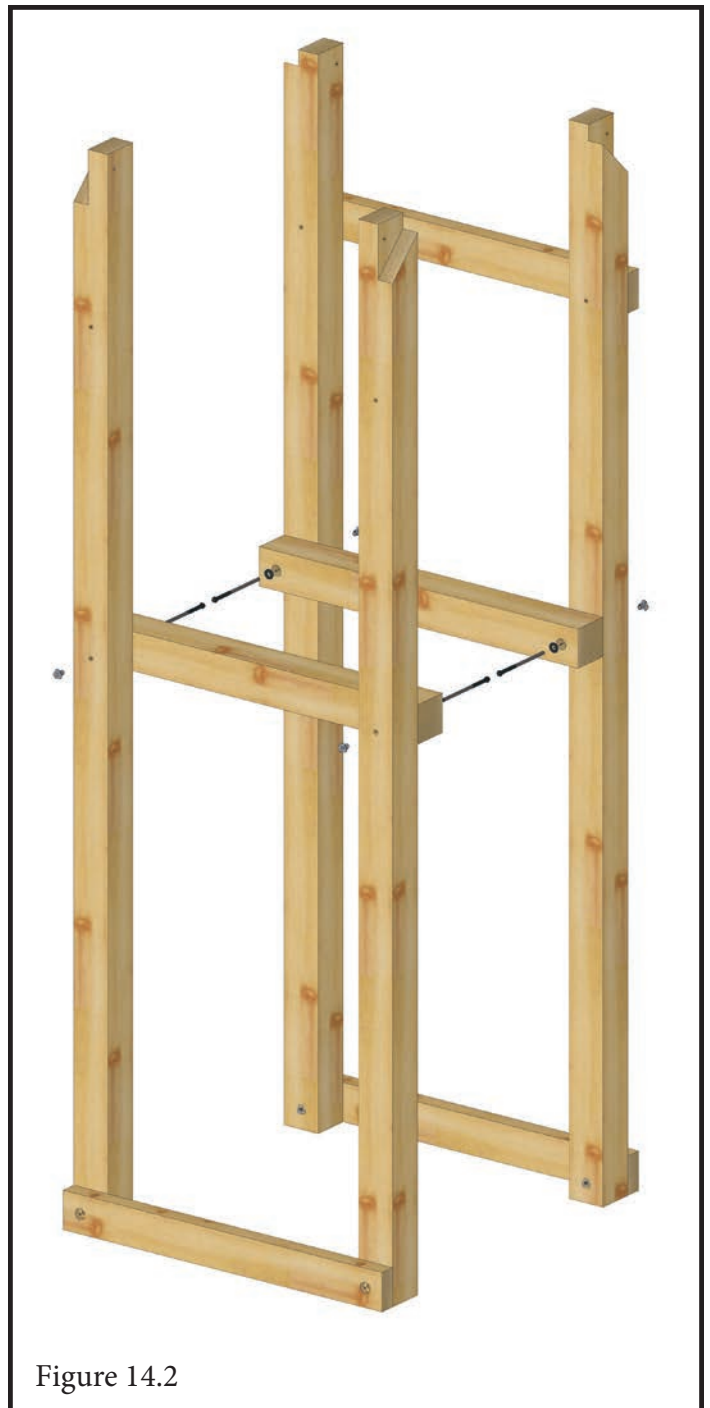

## Step Fifteen: Tower Assembly

15.1 Pre-drill and Fasten Deck Boards 26" (2) to Deck Supports with #8x2-1/2 Screws (4 each) as shown in Figure 15.1.

15.2 Fasten Top Panel Offset 33" and Top Panel (Rope) 33" to bottom of Post with 5/16 x 3 Lag Bolt with 5/16 washer as shown in Figure 15.1.

15.3 Place the towers in desired location. Check for square, level under the frame and check the posts for plumb.

15.4 Fasten Slim Sams (4) to Corner Posts and Deck Supports with 5/16 x 3 Lag Bolts with 5/16 washer as shown in Figure 15.2.

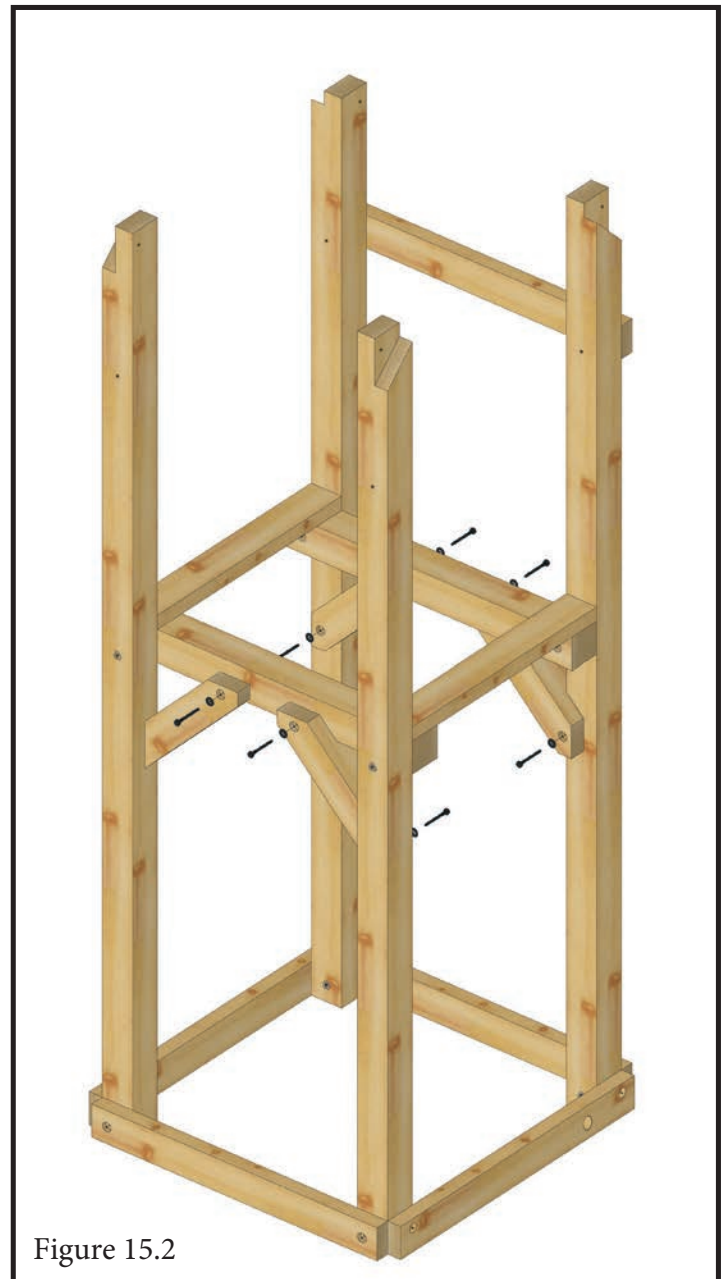

## Step Sixteen: Deck Boards & Fascia Boards

16.1 Pre-drill and evenly space out Deck Boards 33" as shown in Figure 16.1.

16.2 Fasten Fascia 33" (4) to Corner Post with 1/4 x 2-1/2 Lag Bolts with 1/4 washer as shown in Figure 16.2. Mind the offset pattern.

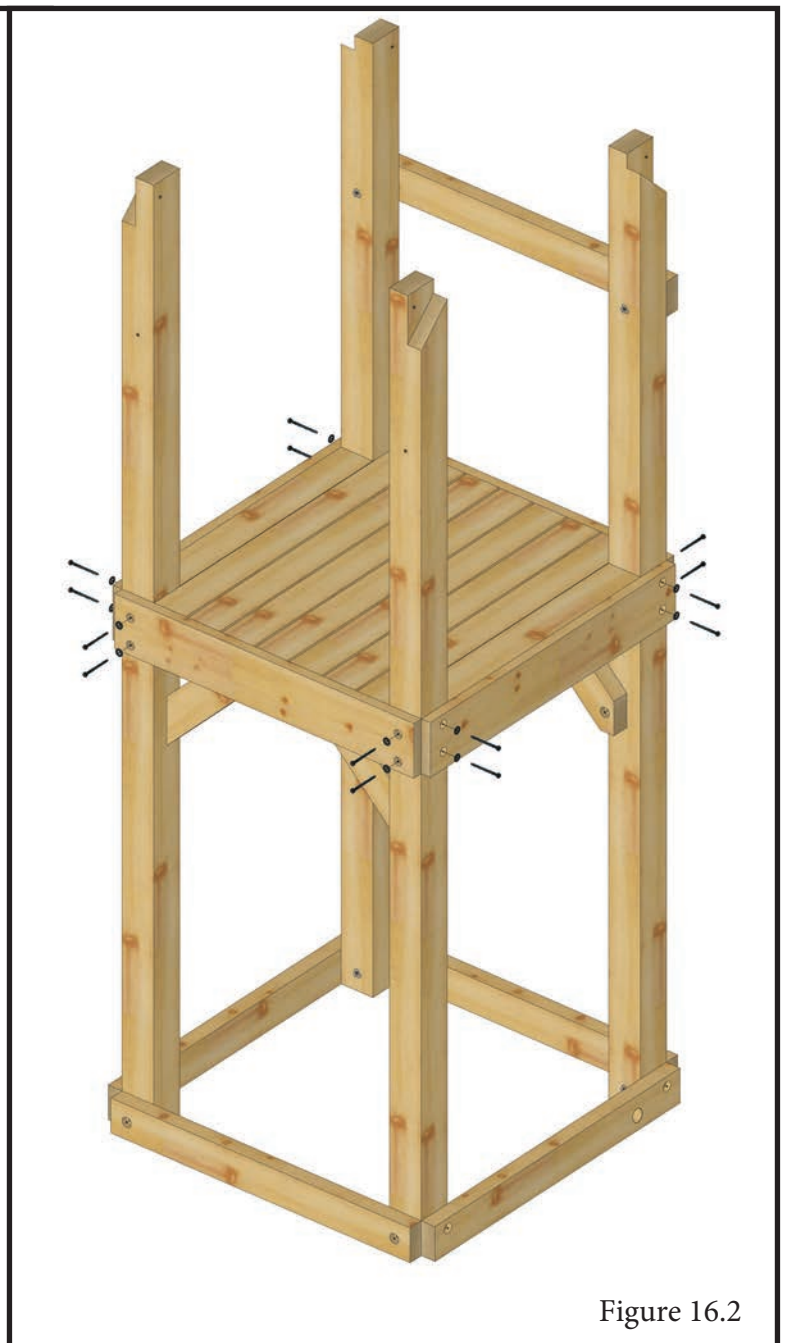
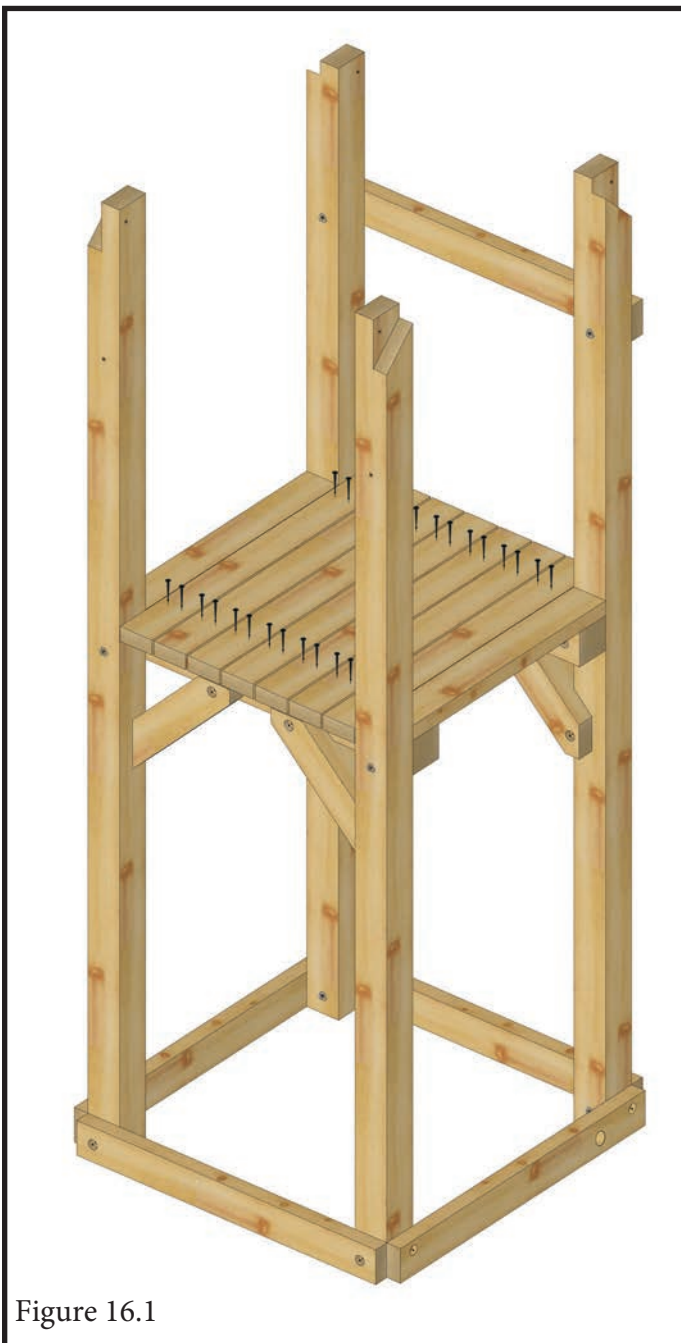

## Step Seventeen: Short Bridge Pre-Assembly

17.1 Fasten GW Deck Supports (2) to Bridge Supports 40" with 5/16 x 4-1/2 Hex Bolts and 5/16 washer into T-Nut as shown in Figure 17.3.

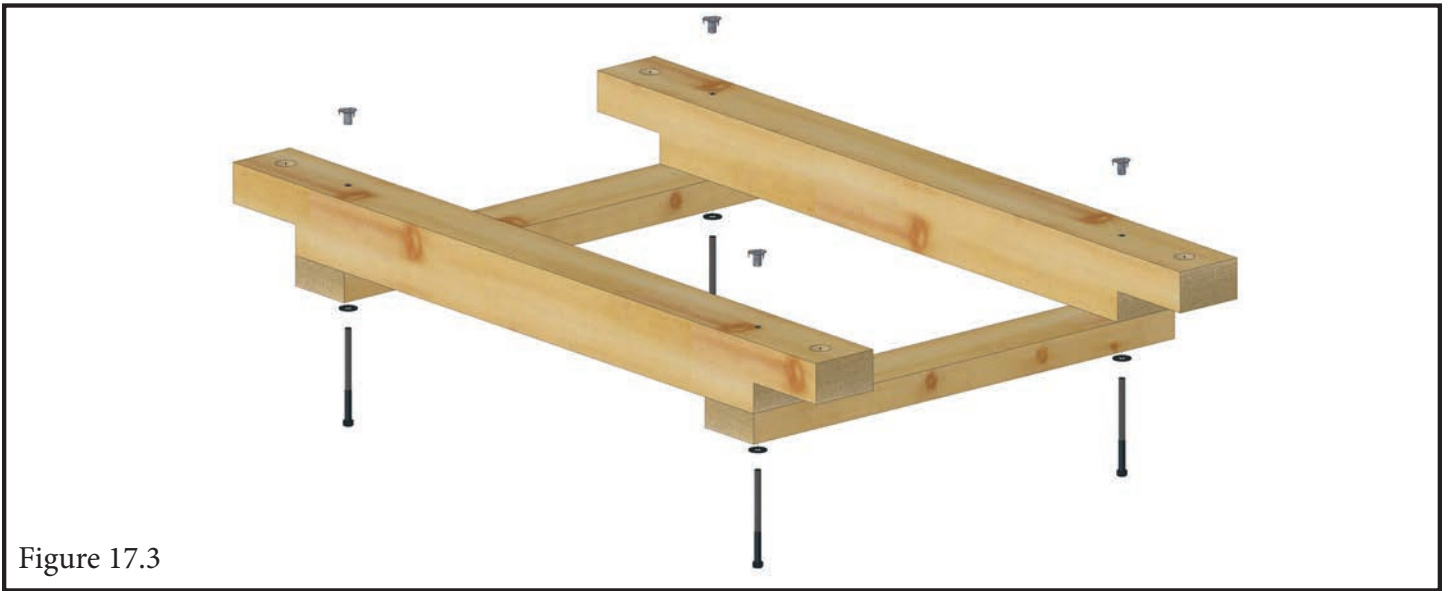

Figure 17.3

## Step Eighteen: Bridge

18.1 Fasten Bridge Assembly down into deck of both towers with 5/16 x 3 Lag Bolts with 5/16 washer.

18.2 Pre-drill and fasten Bridge Deck Boards 33" down with 2-1/2" Screws as shown in Figure 18.1.

18.3 Fasten Bridge Rails 38.5" to the Tower Posts with 5/16 x 3 Lag Bolts with 5/16 washer.

18.4 Pre-drill and Fasten Bridge Rails 38.5" to Top Support Offset 12" with #8x2-1/2" screws as shown in Figure 18.1.

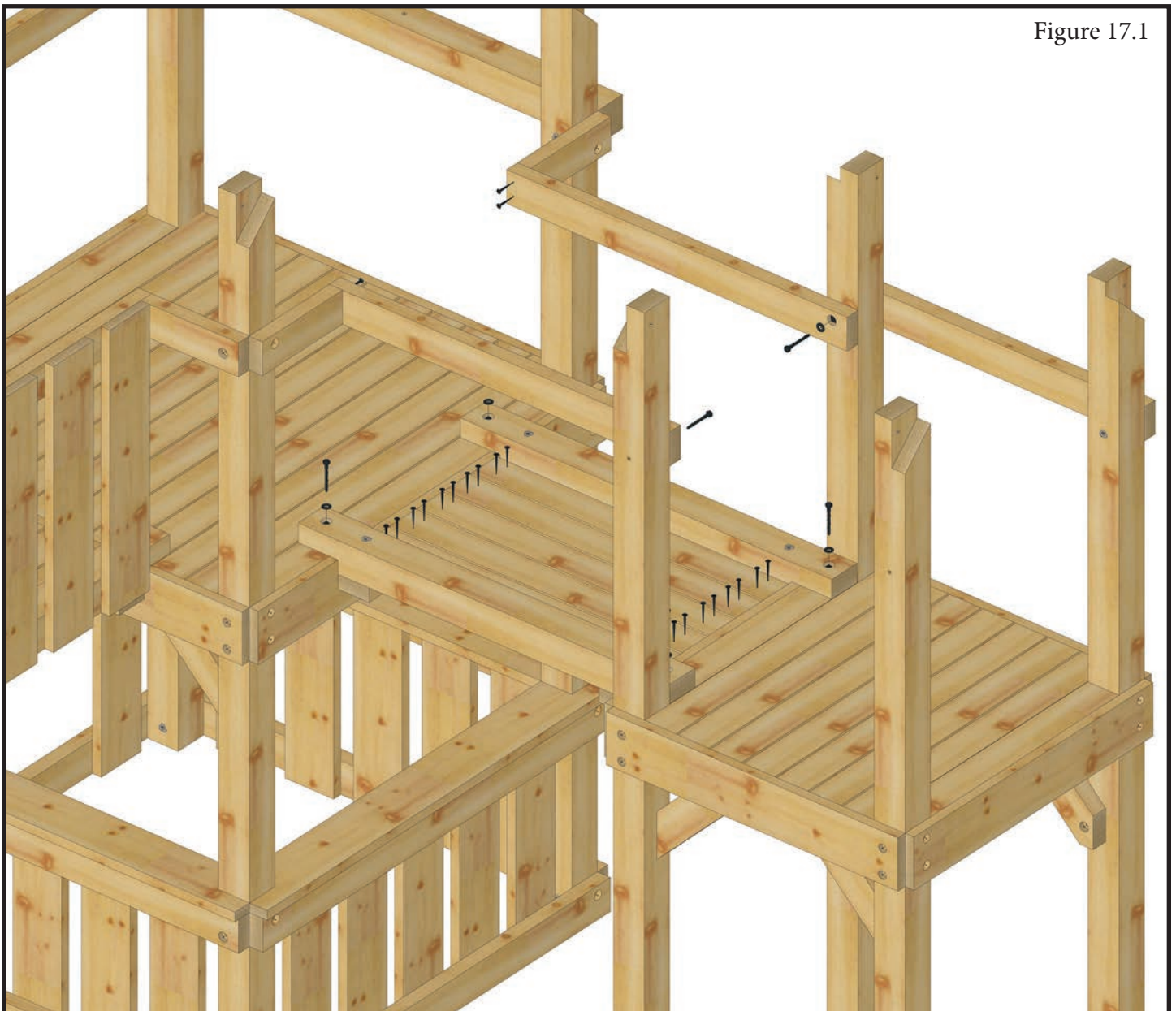

## Step Nineteen: Wall Slats

19.1 With roughly 2-1/4" spacing between slats, fasten the Pocket Slat 28" Boards down to the decks with 2" Screws as shown in Figure 18.2

19.2 Pre-drill and Fasten the top of the Pocket Slat 28" with 2" Screws as shown in Figure 18.1.

19.3 Pre-drill and fasten Slat 29.5" between bridge deck support and bridge rails.

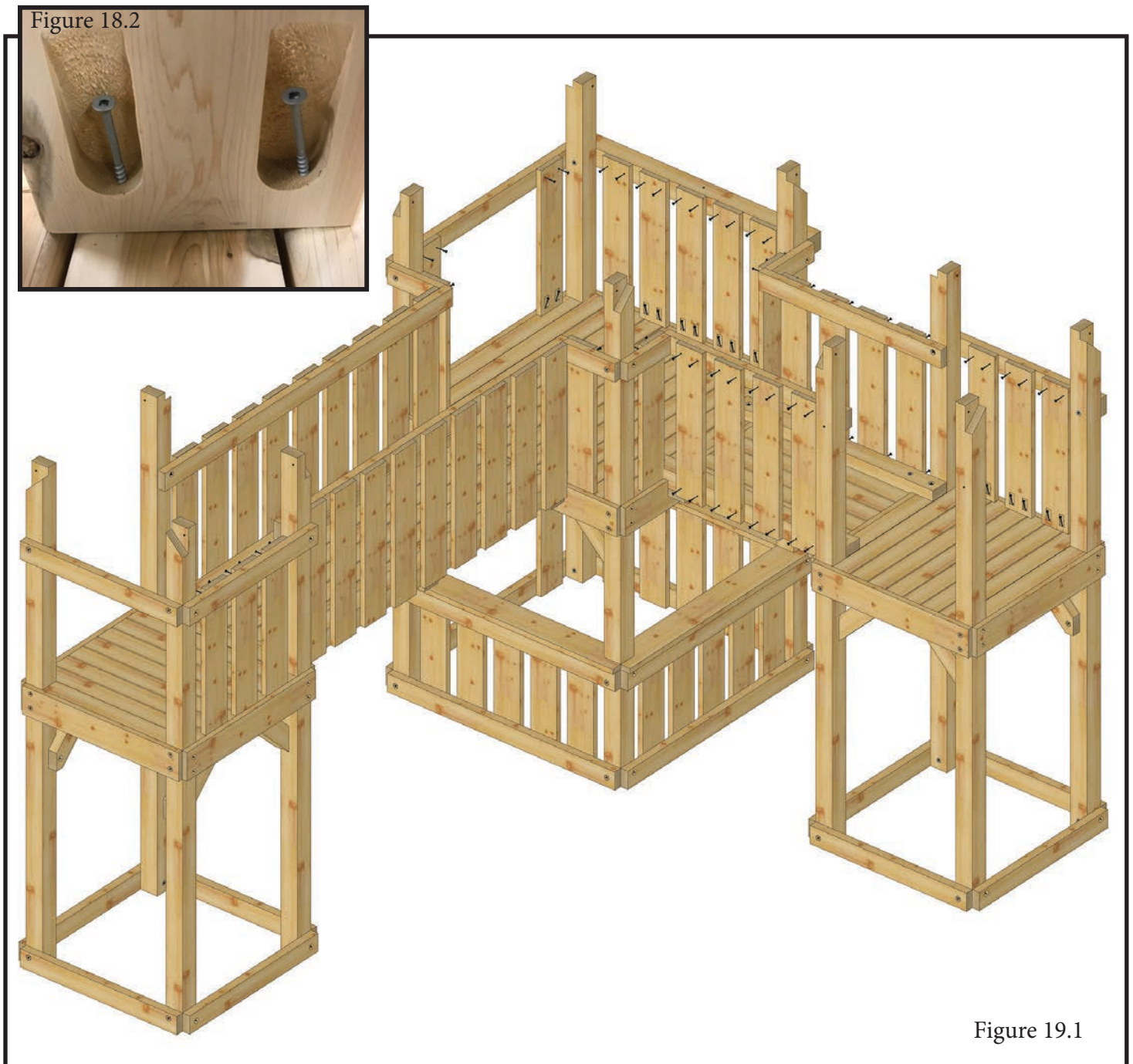

## Step Twenty: Roof Rafters

20.1 Fasten Roof Rafter-L and Roof Rafter-R to Roof Brace with 5/16" x 2" Hex Bolts with 5/16" washers into t-nuts as shown in Figure 20.1. Repeat for opposite peak side.

20.2 Fasten Roof Rafter SH-L and Roof Rafter SH-R to Roof Brace with 5/16" x 2" Hex Bolts with 5/16" washers into t-nuts as shown in Figure 20.2. Make 4 all together.

20.3 Add two 2" screws to align each peak.

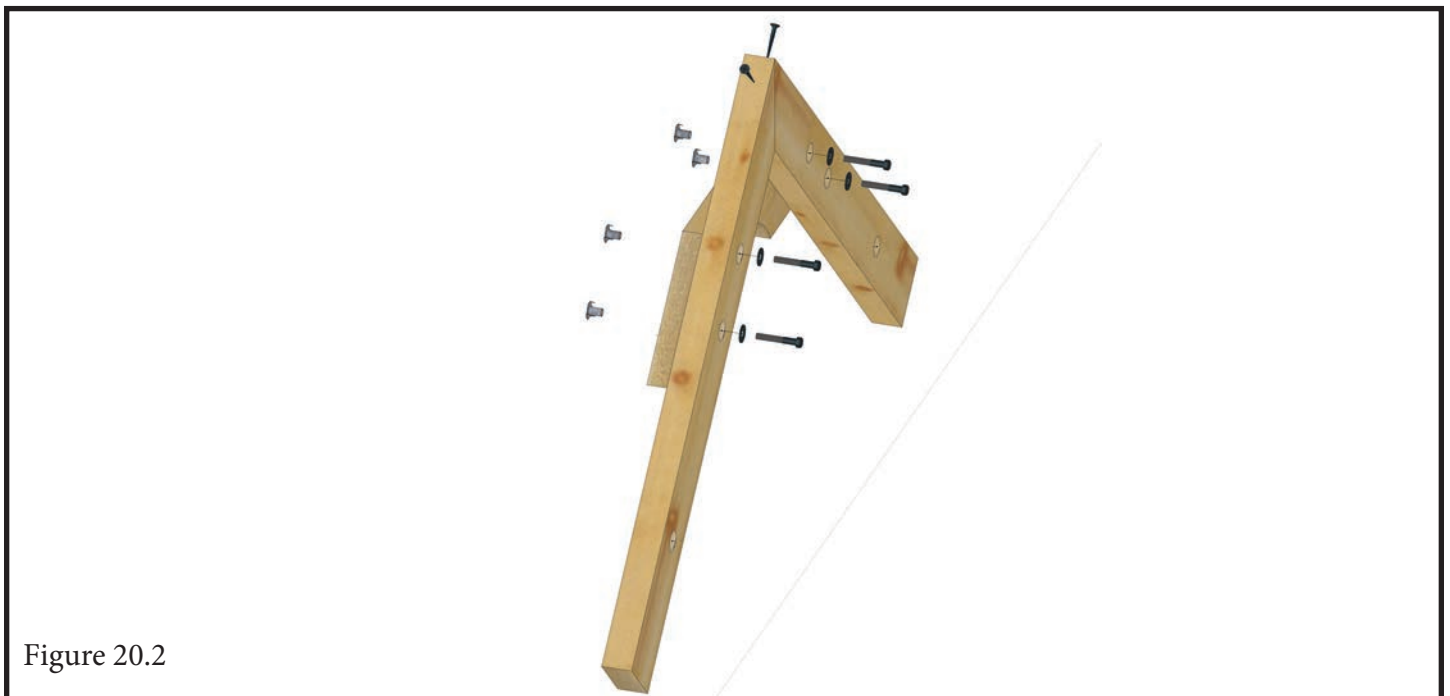
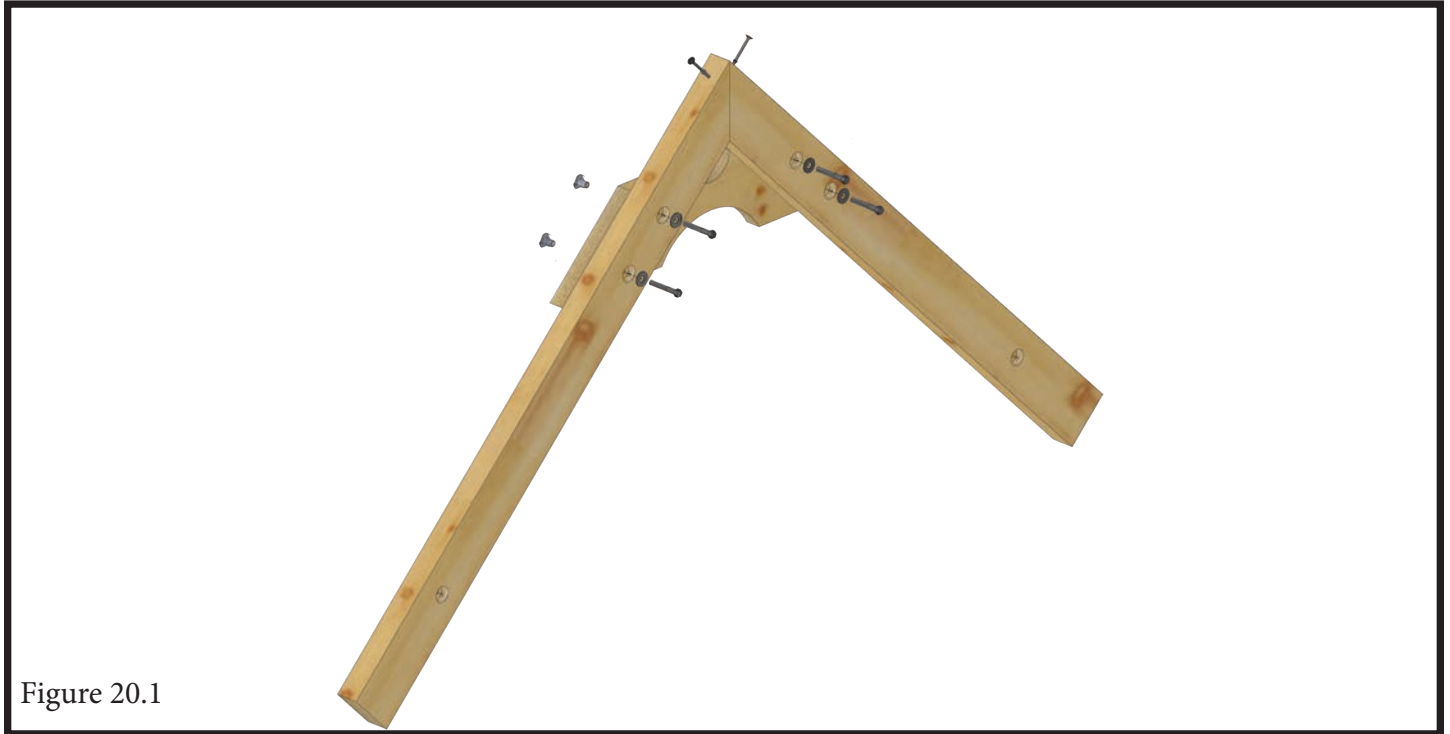

## Step Twenty-One: Roof Rafters

21.1 Fasten Rafter Assemblies to Corner Post with 5/16" x 3" Hex Bolts with 5/16" washer into T-Nuts as shown in Figure 21.1.





## Step Twenty-Two: Wood Roof

22.1 Pre-drill and fasten Roof Peak Boards to Rafter Assembly with 2" Screws as shown.

22.2 Pre-drill and fasten Cupola to Roof Peak Board with 2" Screws as shown (2 per side).

22.3 Pre-drill and fasten Cupola Roof to Cupola with 2" Screws as shown (2 per side).

22.4 Pre-drill and fasten remaining Roof Boards to Rafter Assembly with 2" Screws.

22.5 Pre-drill and fasten Roof Cut Out 1, 2 and 3, in proper size order, to Rafter Assembly with 2" Screws as shown in Figure 22.2.

Figure 22.1

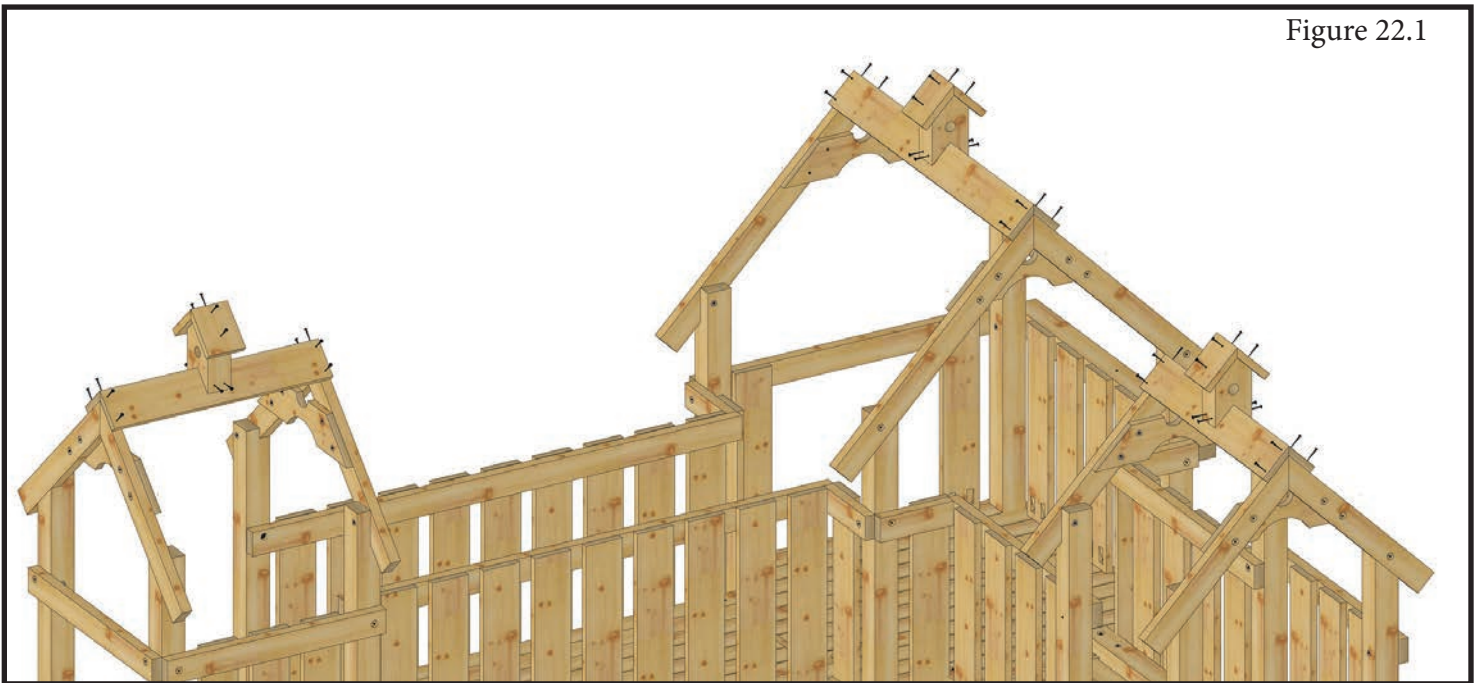

Figure 22.2



## Step Twenty-Three: Dormer

23.1 Fasten Dormer Support-L and Dormer Support-R to Roof Brace with 5/16" x 2" Hex Bolts with 5/16" washers into T-Nuts as shown in Figure 21.1. Add two 2" screws to align each peak.

23.2 Pre-drill and fasten Dormer Boards (Peak L/R, 1 L/R, 2 L/R, 3 L/R, 4 L/R) in proper size order, to Dormer Support Assembly with 2" Screws as shown in Figure 23.2. Add two 2" screws to peak boards.

23.3 Pre-drill and fasten Dormer Assembly to Main Roof with 1-3/4" screws as shown in Figure 23.3.

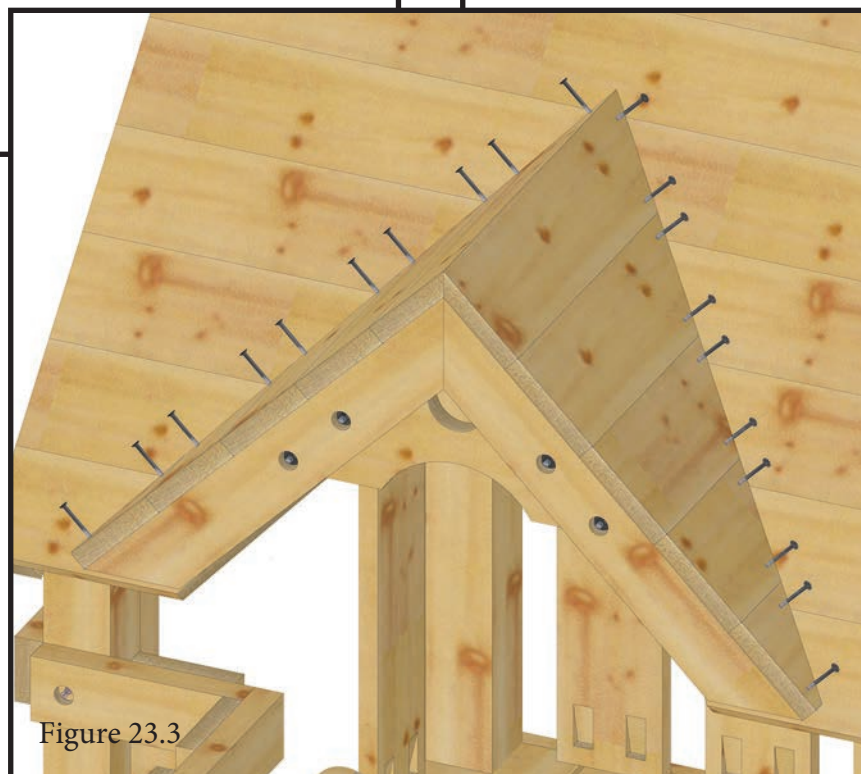
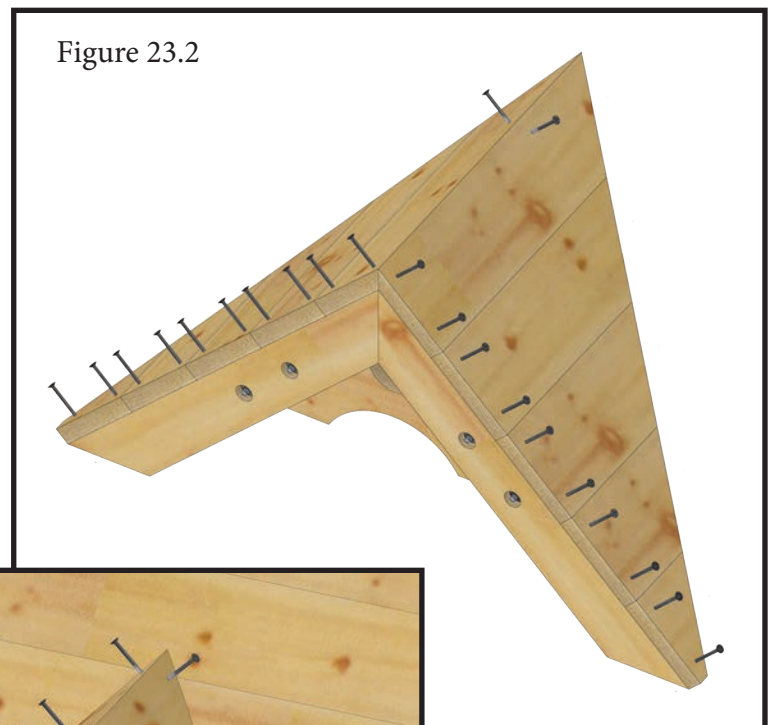
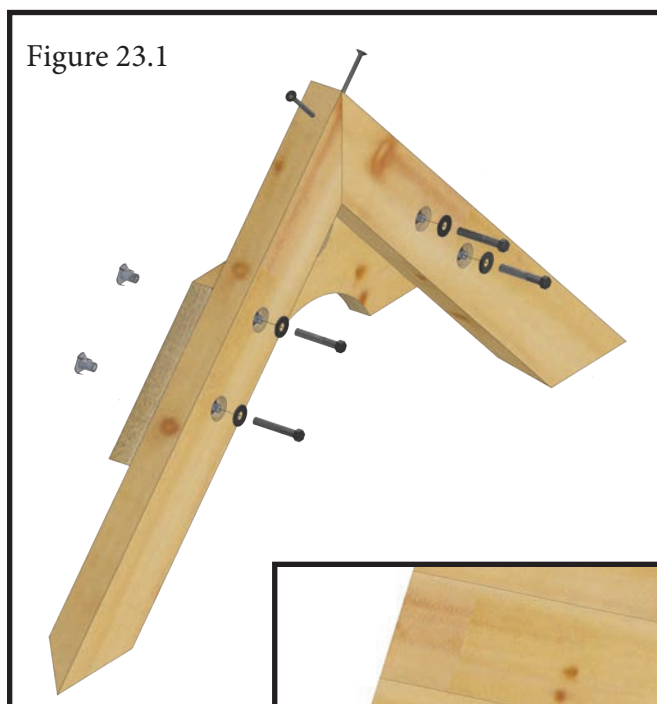

## Step Twenty-Four: Gangway Ladder

24.1 Place Ladder Steps into Dado of GW Ladder Runners as shown in Figure 24.1.

24.2 Pre-drill and fasten Steps with 4" Screws.

24.3 Fasten Bottom Runners to GW Ladder Runners with 5/16 x 6 Hex Bolts and 5/16 washer into T-Nuts as shown in Figure 23.2.

24.4 Fasten Slim Sams (2) between Ladder Runners and Bottom Runners with 5/16 x 3 Lag Bolts with 5/16 washer as shown in Figure 24.2.

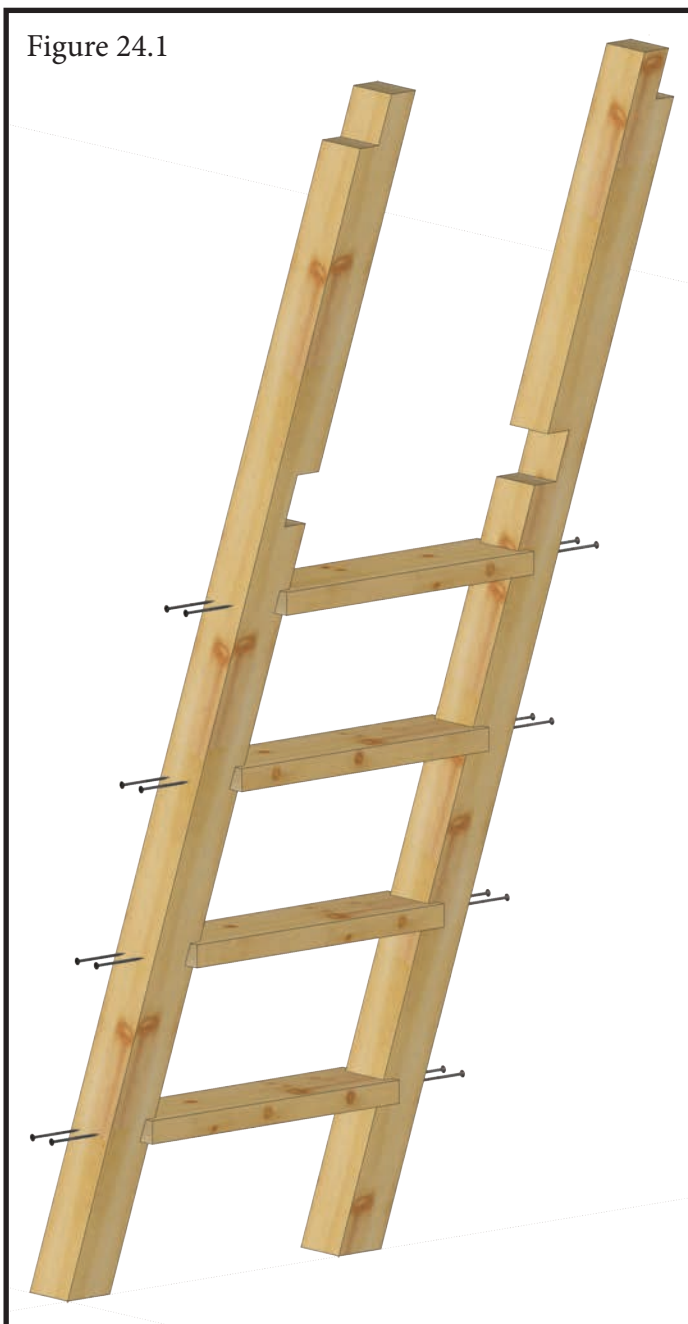

## Step Twenty-Five: Gangway

2451 Fasten Gangway Runners to GW Ladder Runner with 5/16 x 3-1/2 Hex Bolts and 5/16 washer into T-Nuts as shown in Figure 25.2.

25.2 Fasten Gangway Runners down into the play deck with 5/16 x 3 Lag Bolts with 5/16 washer.

25.3 Fasten Gangway Rails Left and Right to the top of the GW Ladder Runners with 5/16 x 3-1/2 Hex Bolts and 5/16 washer into T-Nuts.

25.4 Fasten tower end of Rails to the Corner Post and Gangway Post with 5/16 x 3 Lag Bolts with 5/16 washer.

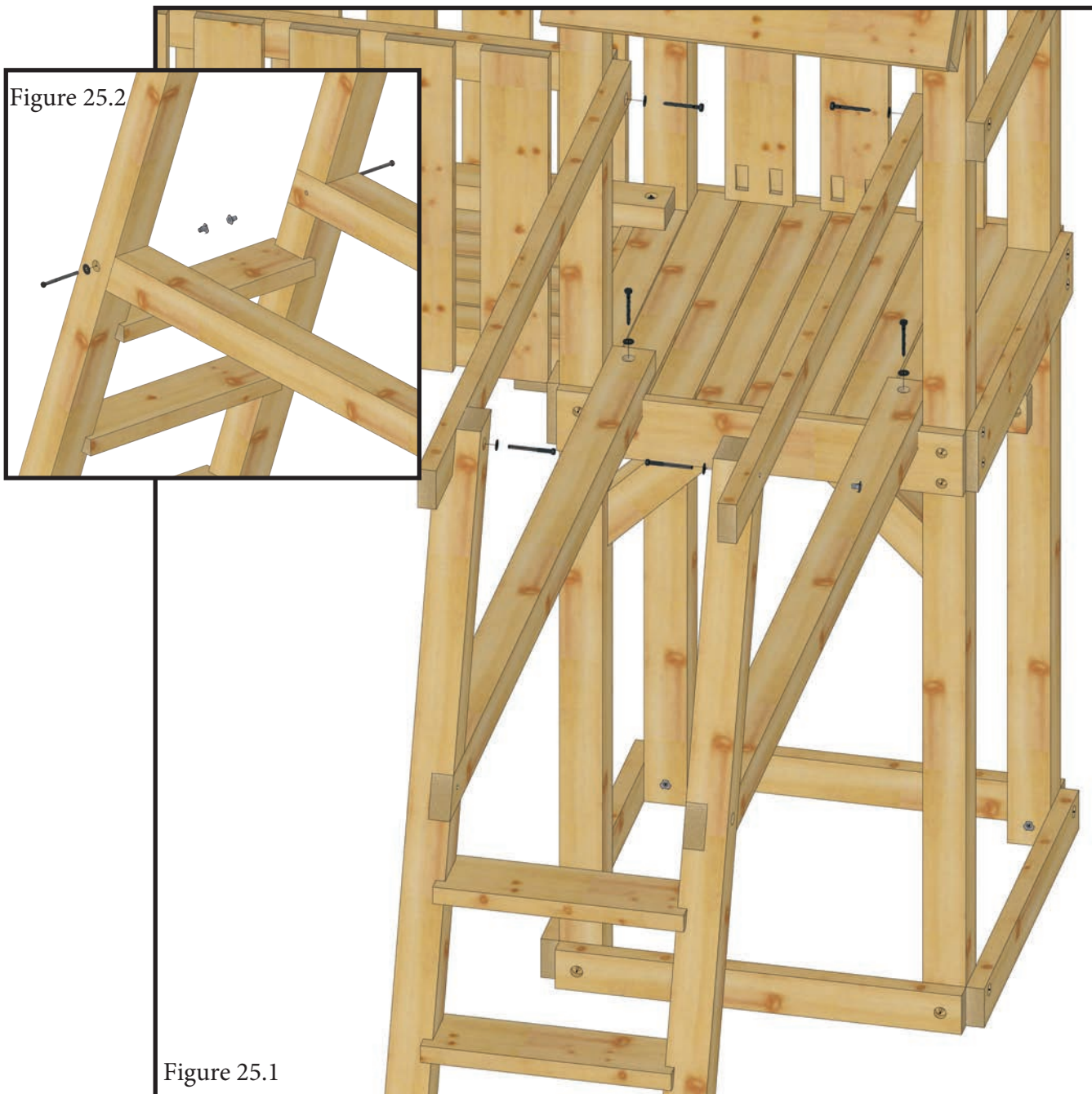

## Step Twenty-Six: Gangway (cont.)

26.1 Fasten GW Ladder Top to the top of the GW ladder Runners with 2-1/2" Screws (4) as shown in Figure 26.1.

26.2 Fasten GW Deck Supports (3) to Gangway Runners with 5/16 x 4-1/2 Hex Bolts and 5/16 washer into T-Nut as shown in Figures 26.1 and 26.2.

26.3 Fasten Deck Support to back of GW Ladder Runners with 5/16 x 3 Lag Bolts with 5/16 washer as shown Figure 26.2.

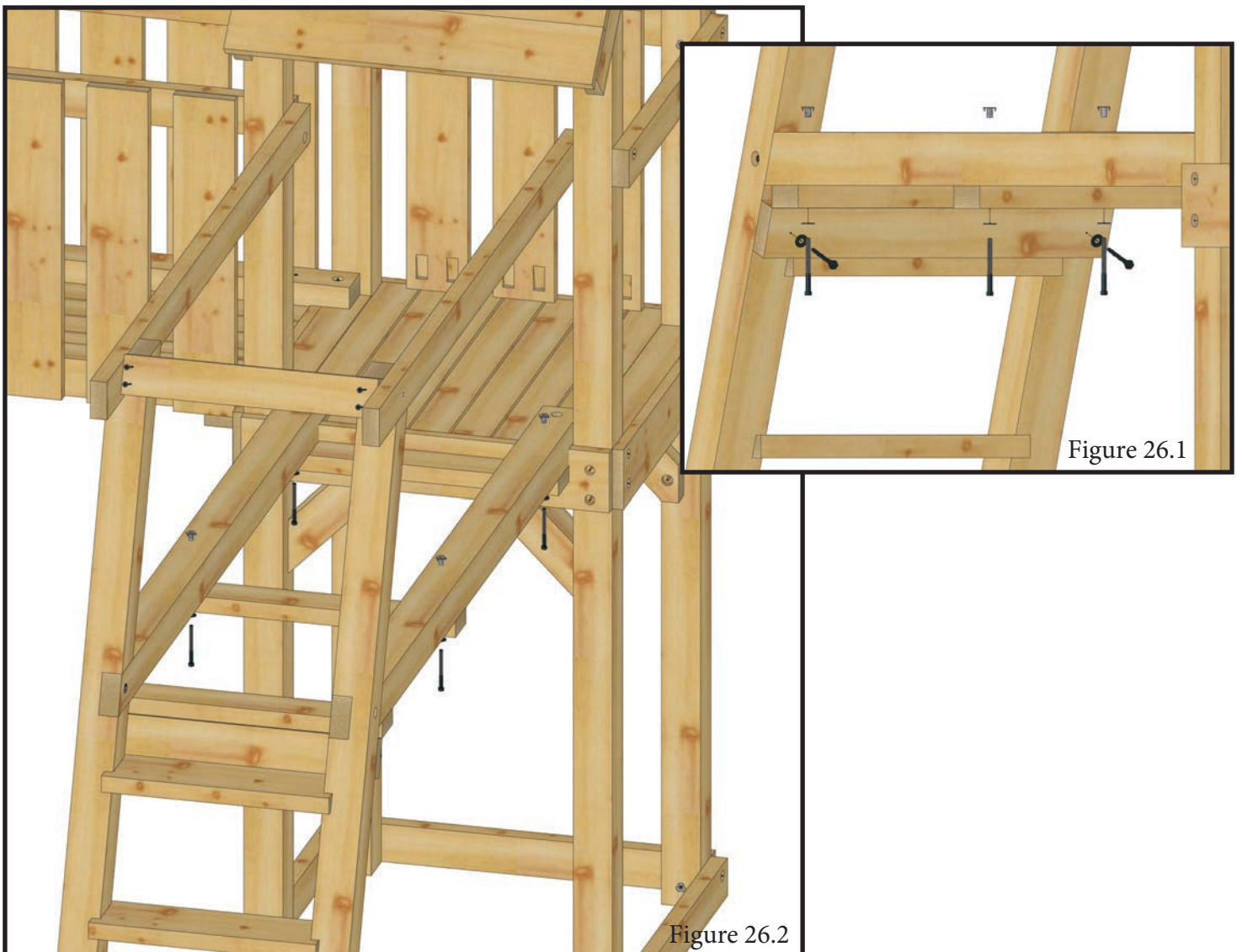

## Step Twenty-Seven: Gangway (cont.)

27.1 Pre-drill and fasten Gangway Deck Boards Down with 2-1/2" Screws as shown in Figure 27.1.

27.2 Pre-drill and fasten Gangway Slats with 2" Screws as shown in Figure 27.2. Space out evenly, leaving about 2-1/4" between boards.



Figure 27.1

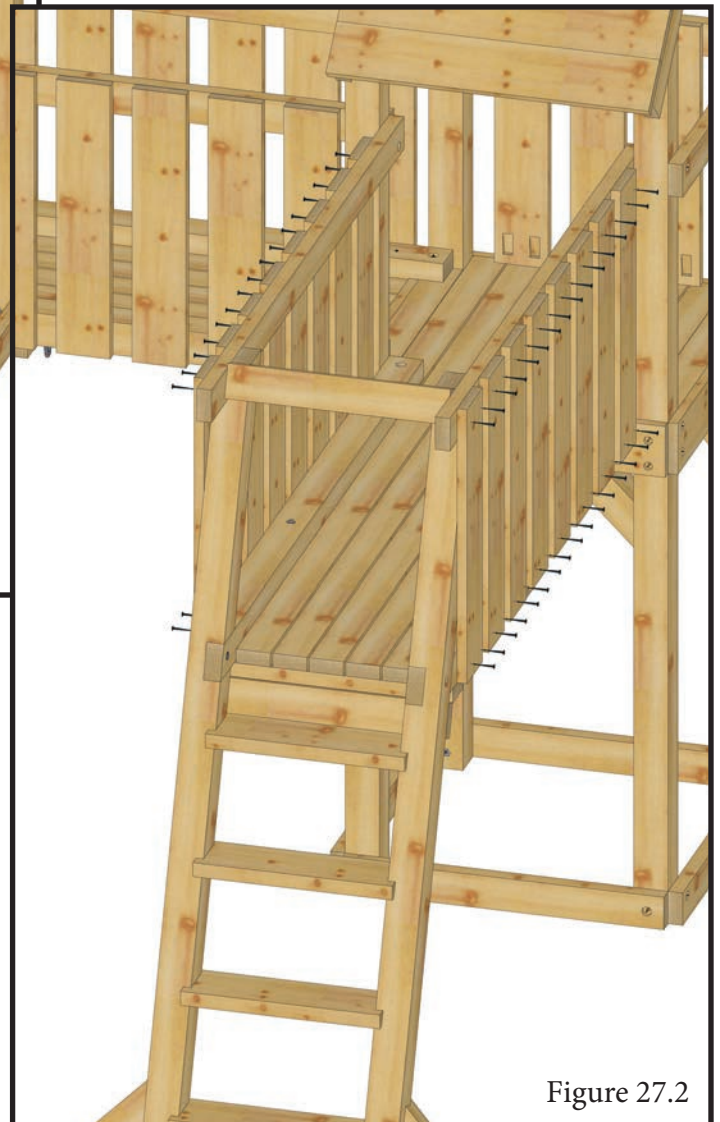

Figure 27.2

## Step Twenty-Eight: Counter

28.1 Measure up from ground 22-1/2 inches and mark the corner posts.

28.2 Fasten Top Panel Offset 33" to Corner Post with 5/16 x 3 Lag Bolts with 5/16 washer as shown in Figure 28.1.

28.3 Pre-drill and fasten Slat 22.5 to Top Panels with #8x2 screws as shown in Figure 28.2. (Spacing between slats is about 2-3/8")

28.4 Pre-drill and fasten Counter 33" to Top Panel with #8x2 screws as shown in Figure 28.1.

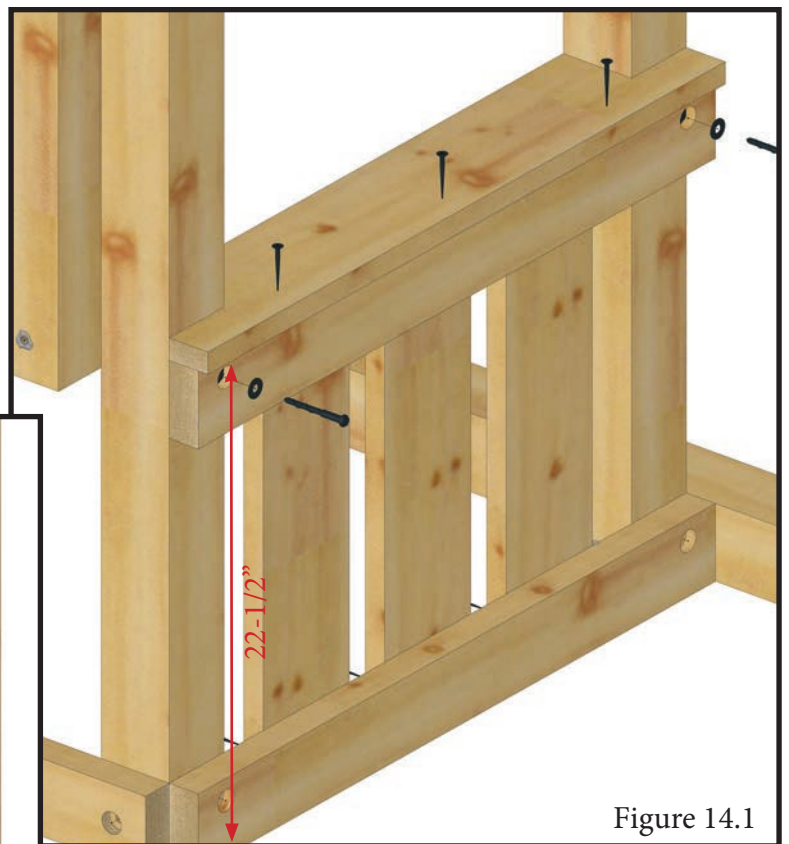

Figure 14.1



Figure 14.2

## Step Twenty-Nine: Bench

29.1 Pre-drill and fasten Bench Blocks to Bench Legs with 1-3/4" Screws as shown in Figure 29.1.

29.2 Pre-drill and fasten Bench Brace to Bench Leg Assemblies with 1-3/4" Screws as shown in Figure 29.2.

29.3 Pre-drill and fasten Bench Tops to Bench Assembly with 1-3/4" Screws as shown in Figure 29.3.

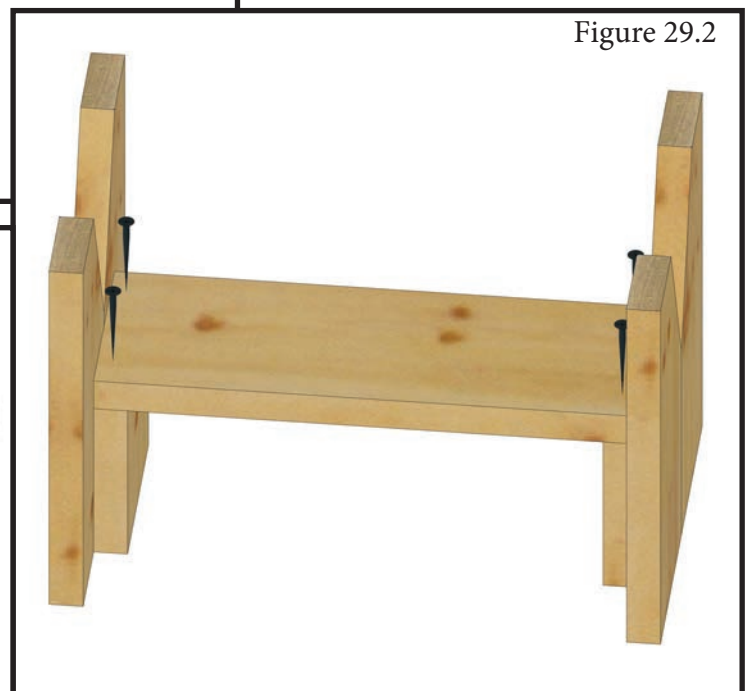
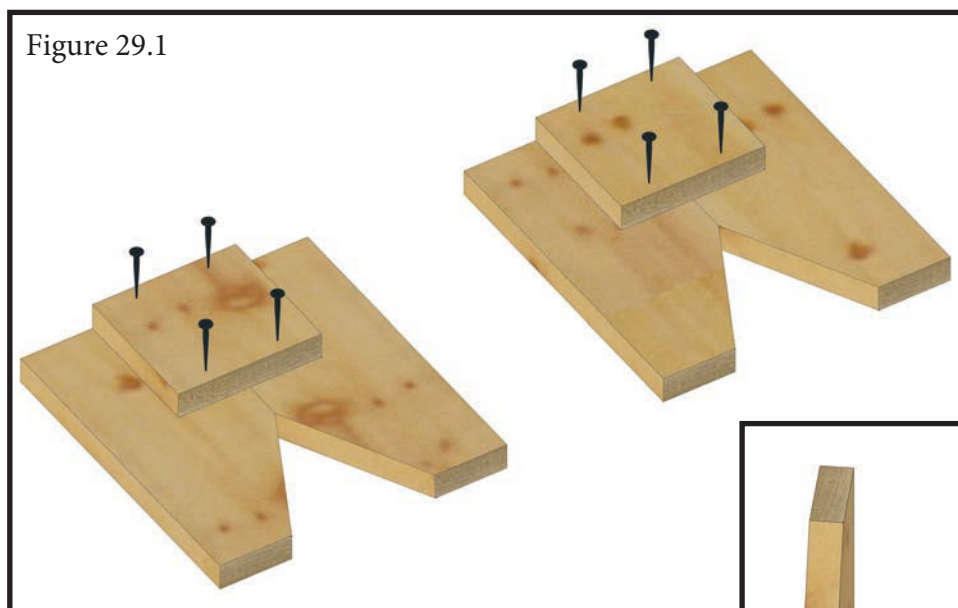

Figure 29.3



## Step Thirty: Rock Wall Pre-Assembly

30.1 Measure up from the bottom (back) of Rock Wall Runners 2-3/8" and Mark.

30.2 Pre-drill and fasten Slat 22.5" (9) to Rock Wall Runners with 2" Screws.

Figure 30.1

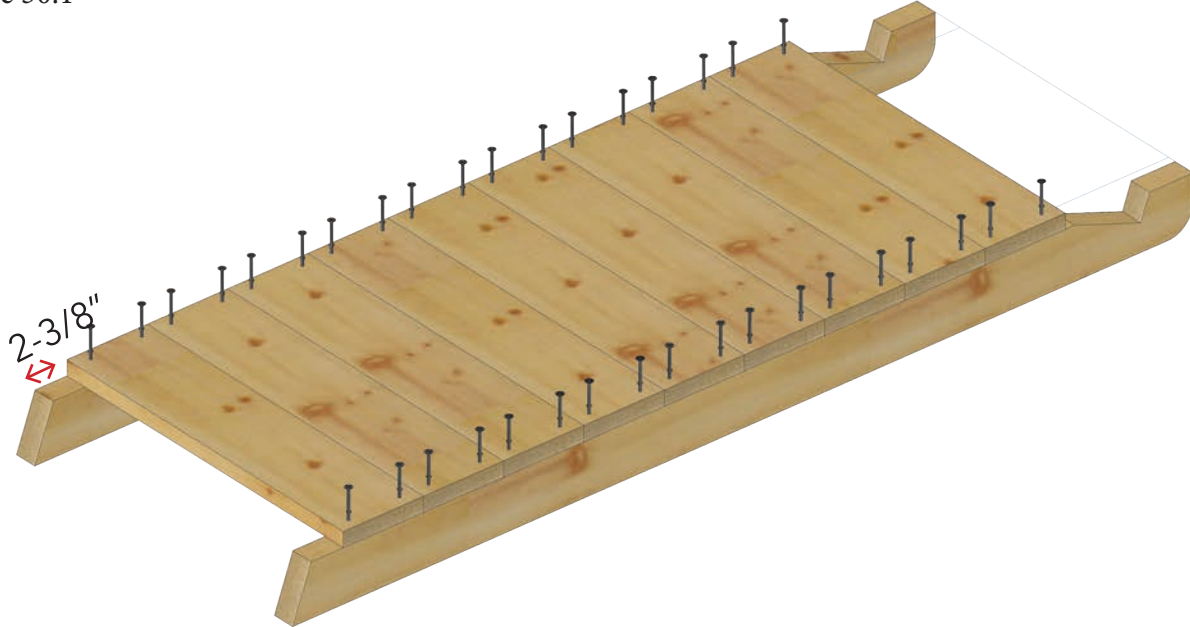

Figure 30.2



30.3 Place plastic Rocks in desired positions.

30.4 With a 3/8 drill bit, drill holes through the rock and the slat.

30.5 Hammer in T-Nuts to back of the wall.

30.6 Fasten plastic rocks with 5/16" x 1-1/2" hex bolts with 5/16" washers.

## Step Thirty-One: Ramp Pre-assembly

31.1 Fasten GW Deck Supports (3) to Ramp Runner with 5/16 x 4-1/2 Hex Bolts and 5/16 washer into T-Nut as shown in Figure 31.1

31.2 Pre-drill and fasten Ramp Boards (5) down with 2-1/2" (6 each) Screws as shown in Figure 31.2.

31.3 Pre-drill and fasten Ramp Treds (7) down with 2" (5 each) Screws as shown in Figure 31.3. Start with the center Tred and work out. The spacing is 10".

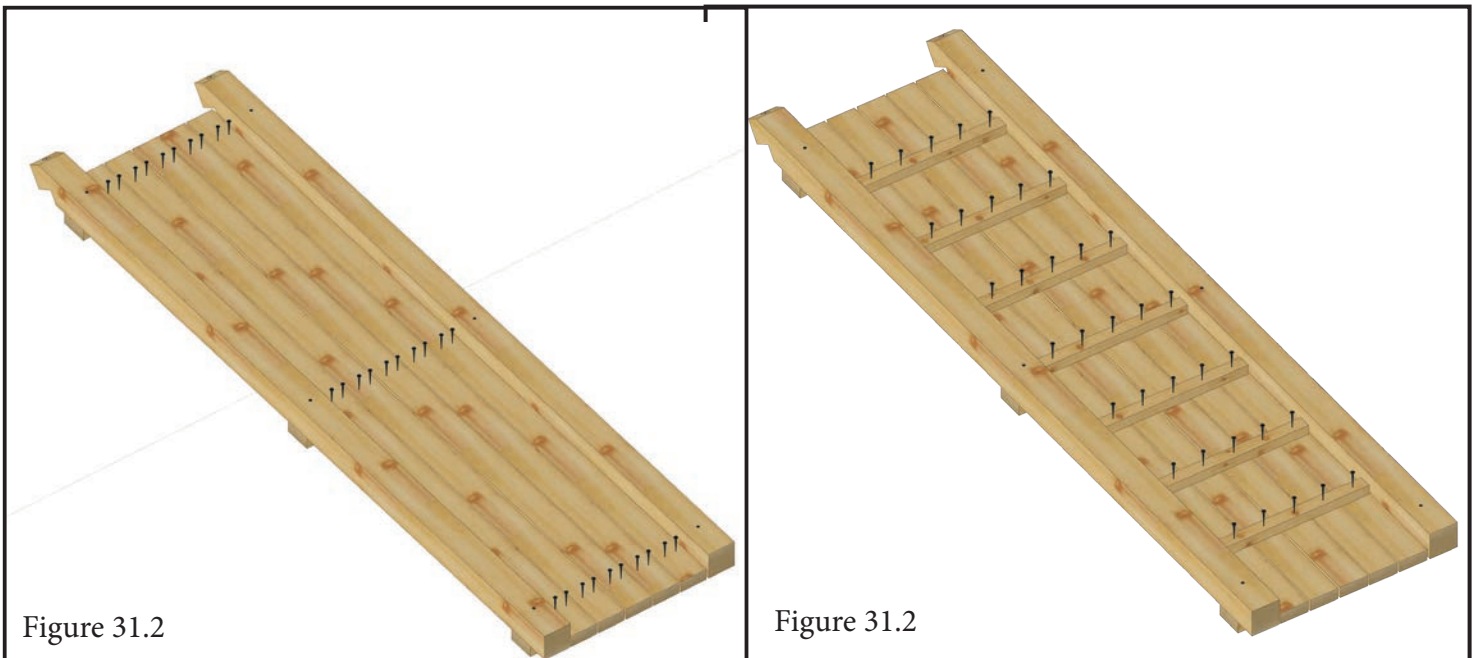
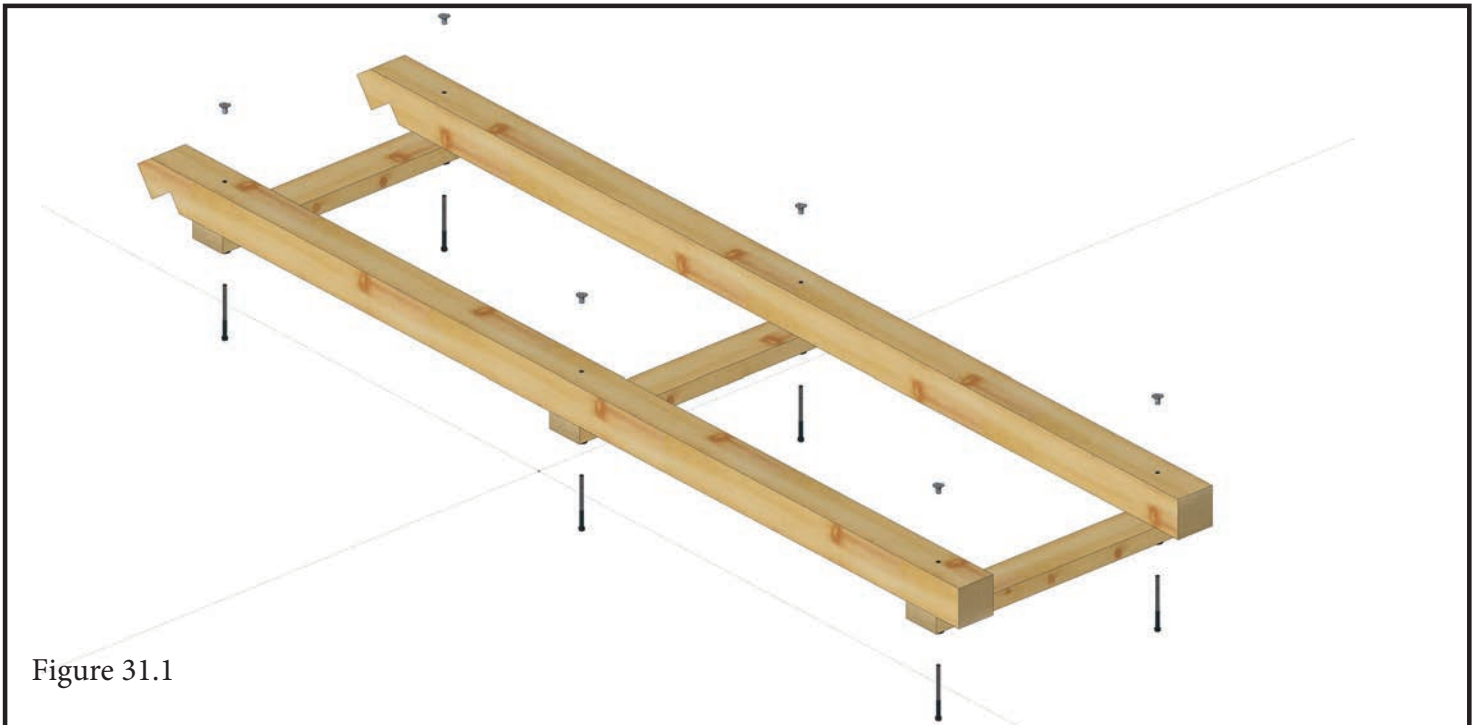

### Step Thirty-Three Continue: Ramp Pre-assembly

33.1 Fasten Ramp Assembly to Tower deck with 5/16 x 3 Lag Bolts with 5/16 washer.

33.2 Tie Ramp Rope between Ramp and Ramp Blocks.

33.3 Fasten Ramp Blocks to tower with 5/16 x 5 Lag Bolts with 5/16 washer as shown in figure 33.1



Figure 33.1

## Step Thirty-Four: Attaching the Rock Wall

34.1 Fasten Rock Wall Assembly to Fascia Gable Side with (2) 5/16 x 3 Lag Bolts with 5/16 washer as shown in Figure 34.2.



Figure 34.1

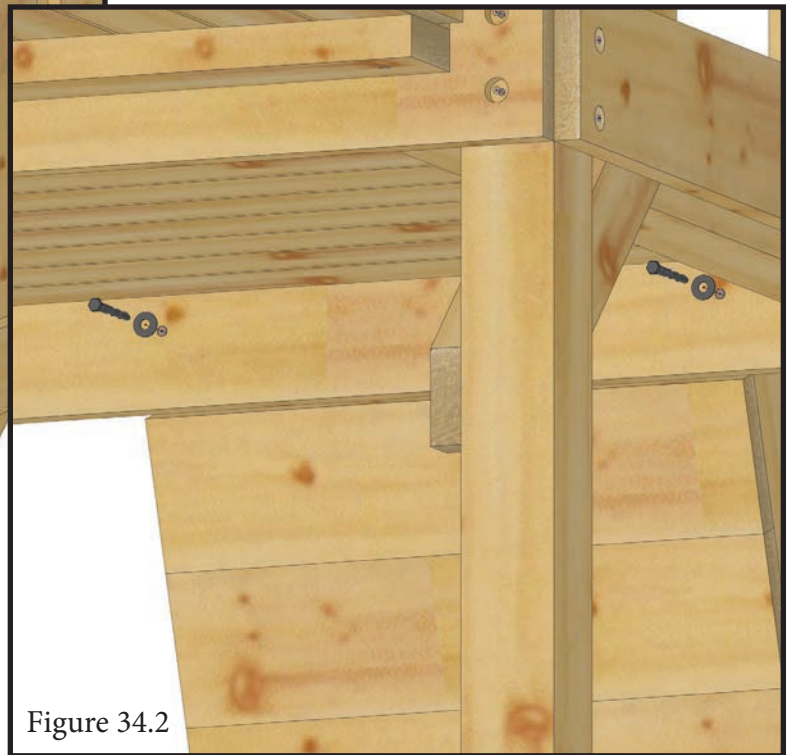

Figure 34.2

## Step Thirty-Five: Firepole / Rope

35.1 Fasten Firepole Beams into Tower posts with 5/16 x 5 Lof Bolts with 5/16 washer as shown in Figure 17.2. Make sure the Firepole holes are facing down.

35.2 Fasten Slim Sams to Tower Posts and Firepole Beams with 5/16 x 3 Lag Bolts with 5/16 washer as shown in Figure 17.2.

35.3 Dig a hole directly under the firepole, about 8" down. Insert the Firepole into the Firepole beam, and fill in under the pole with something rigid, such as a flat rock, paver or brick, to ensure the pole does not sink. Concrete can also be used.

35.4 Tie the Rope through the Firepole Beam. Tie 7 knots down the rope, and tie through the rope hole in the Top Panel 33" as shown in Figure 35.3.

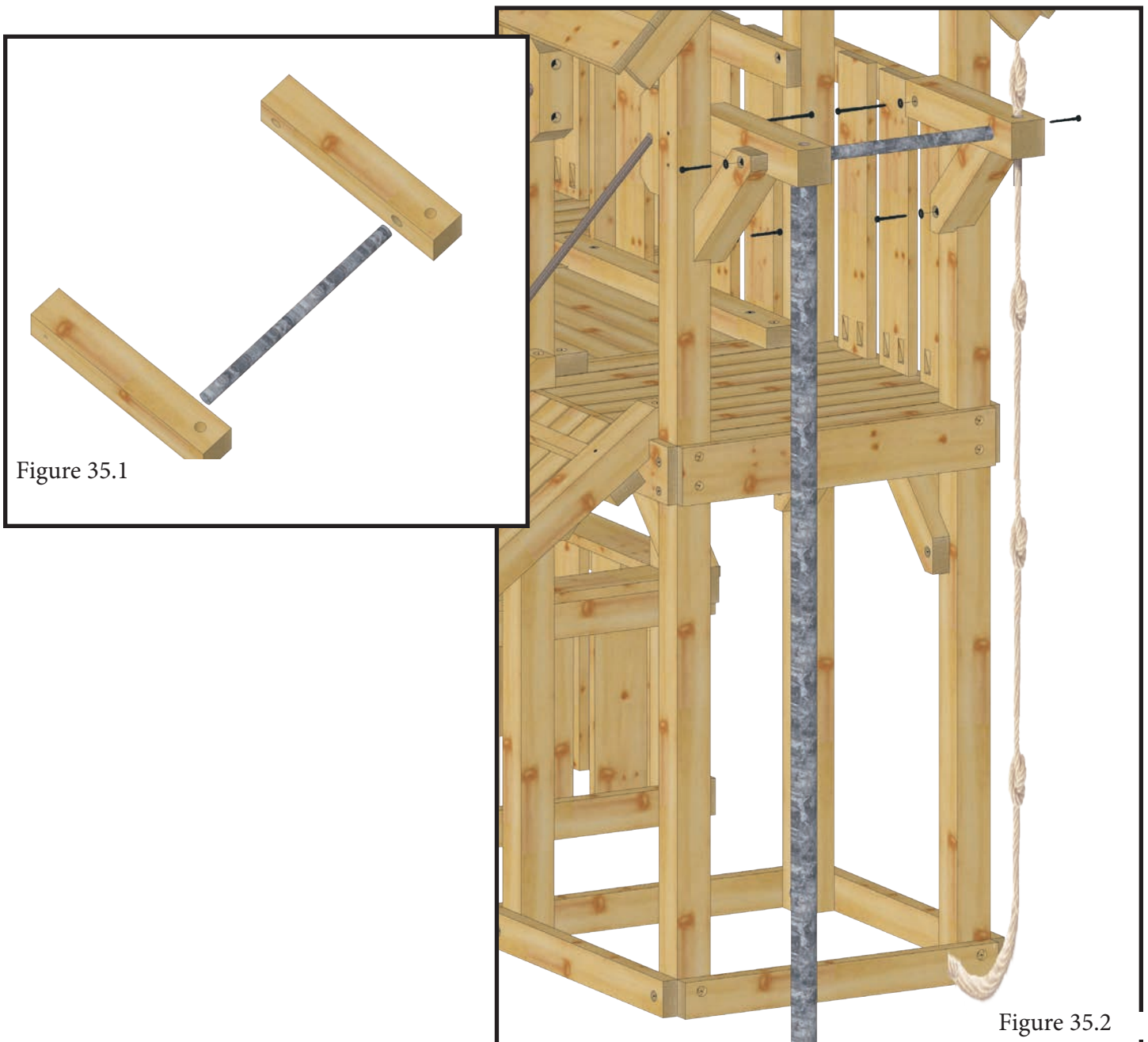

## Step Thirty-Six: A-Frame Pre-Assembly

36.1 Fasten Swing Legs to bracket with 3/8" x 4-1/2" Carriage Bolts with 1/2 Washers. Add 3/8" Washer, Lock Washer, and Nut as shown in Figure 36.1. Do Not Fully Tighten.

36.2 Fasten X-Member between Swing Legs with 5/16"x 4-1/2" Hex Bolts with 5/16" Washer into T-Nuts as shown in Figure 36.2. Do Not Fully Tighten.

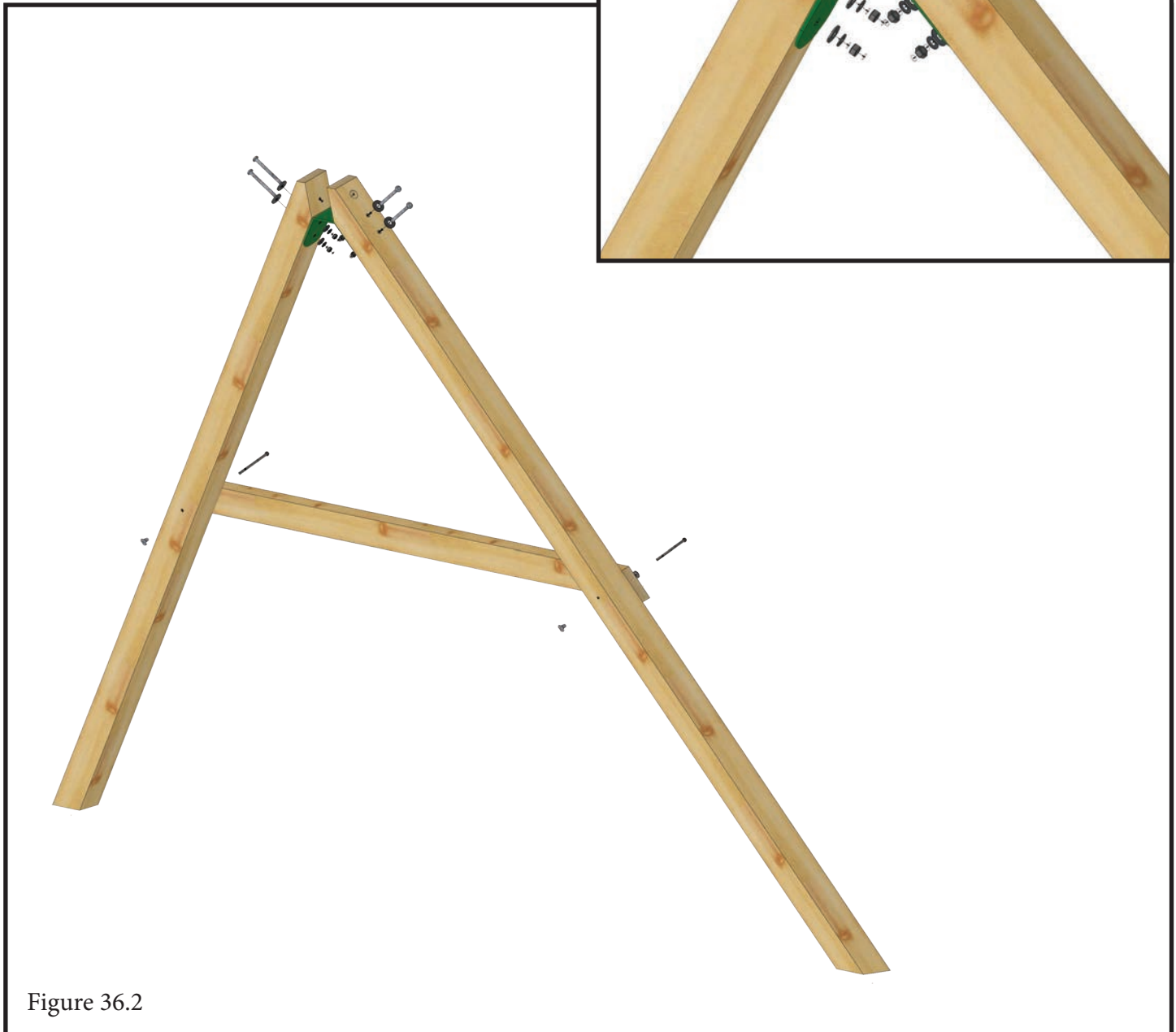
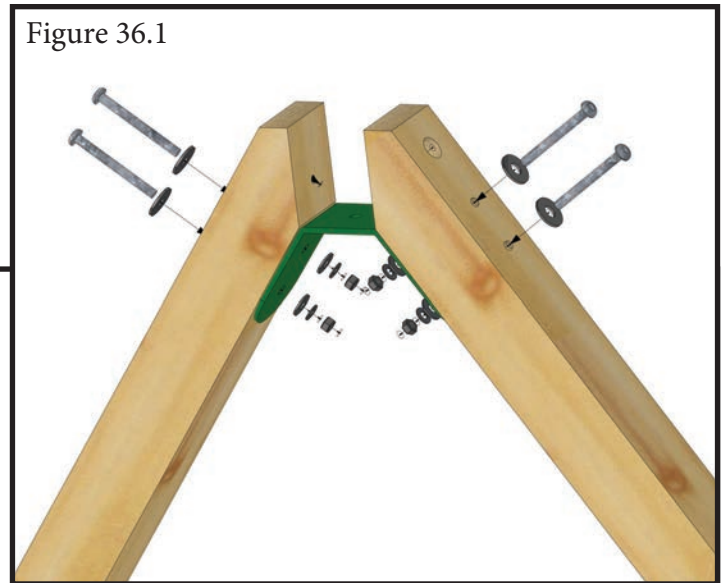
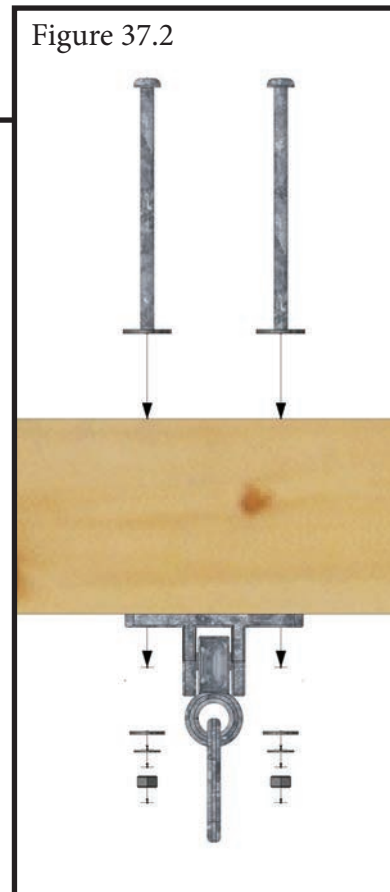
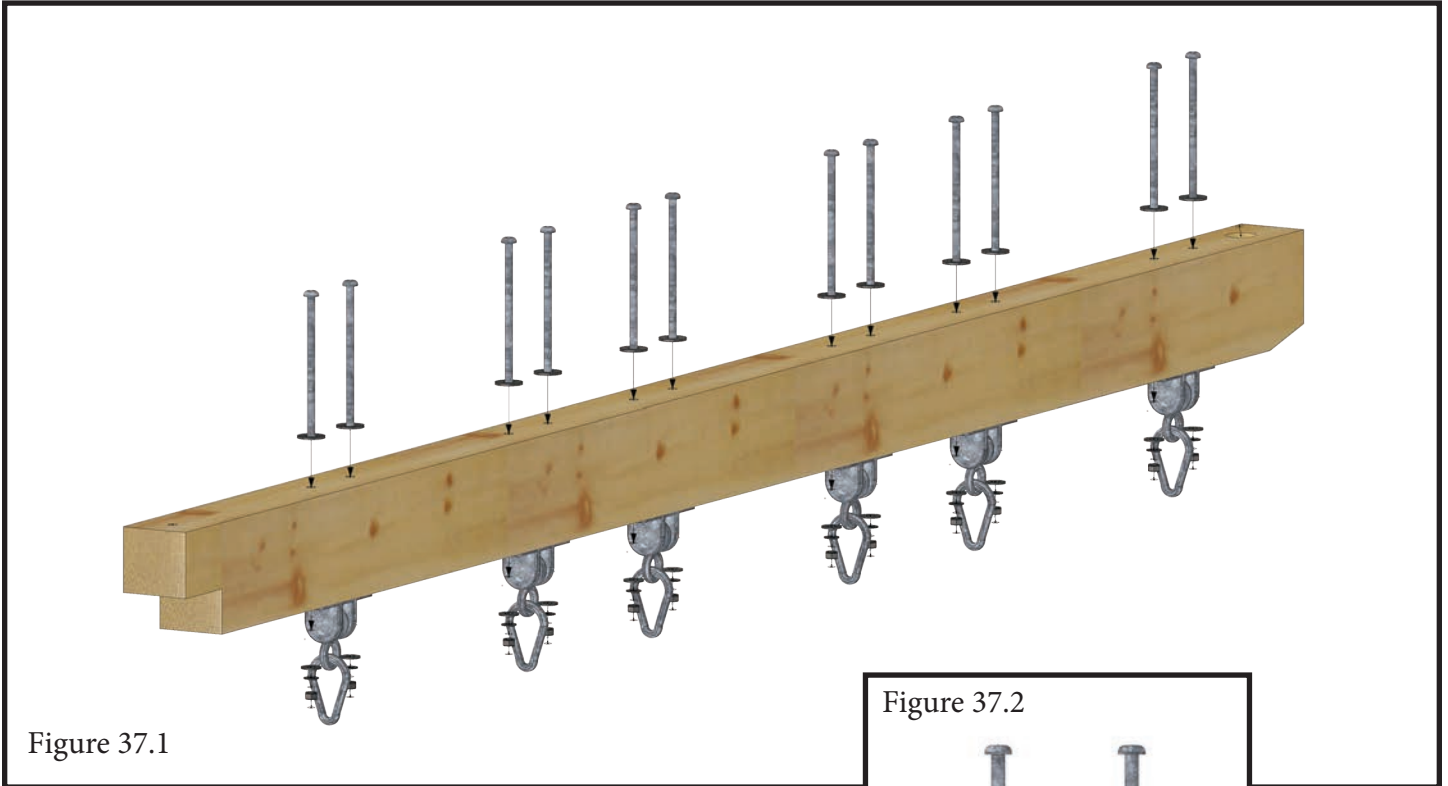

Figure 36.2

## Step Thirty-Seven: Swing Beam Pre-Assembly

37.1 Fasten Swing Hangers to Swing Beam with 3/8" x 7" Carriage Bolts with 1/2" Washers. Add 3/8" Washer, Lock Washer, and Nut as shown in Figure 37.2. Tighten until 1/2" washers just start to "sink" into top of beam.

37.2 Snap Spring Clips to Swing Hangers.



## Step Thirty-Eight: Swing Arm Assembly

38.1 Fasten Swing Beam Assembly to A-Frame Assembly with 3/8" x 5" Carriage Bolt with 1/2" Washer. Add 3/8" Washer, Lock Washer, and Nut. Tighten.

38.2 Fully tighten nuts from step Thirty-Six.

38.3 Fasten the top of the Swing Legs into the Swing Beam with 5/16" x 3" Lag Bolts with 5/16" washer as shown in Figure 38.1.

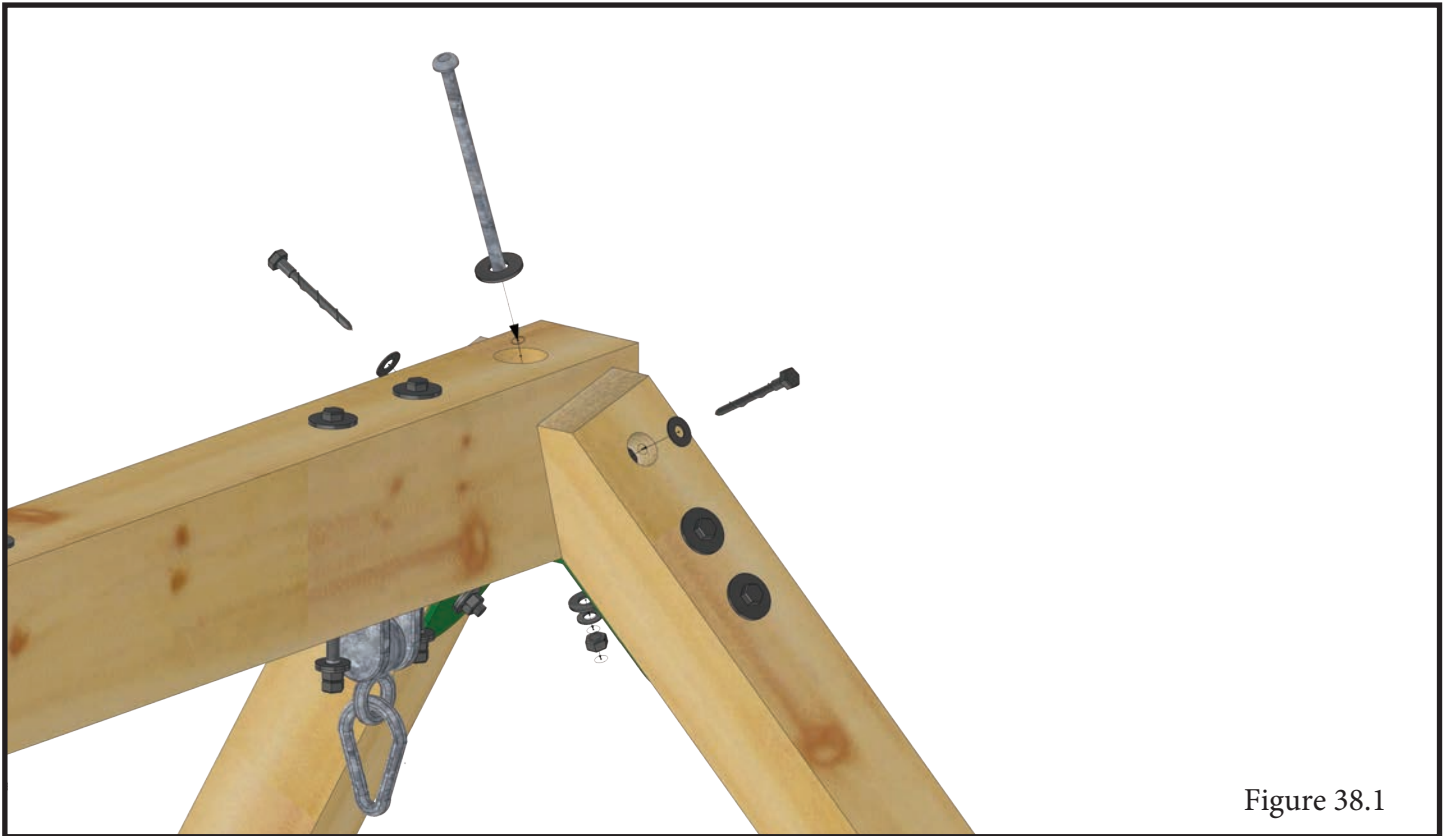

Figure 38.1

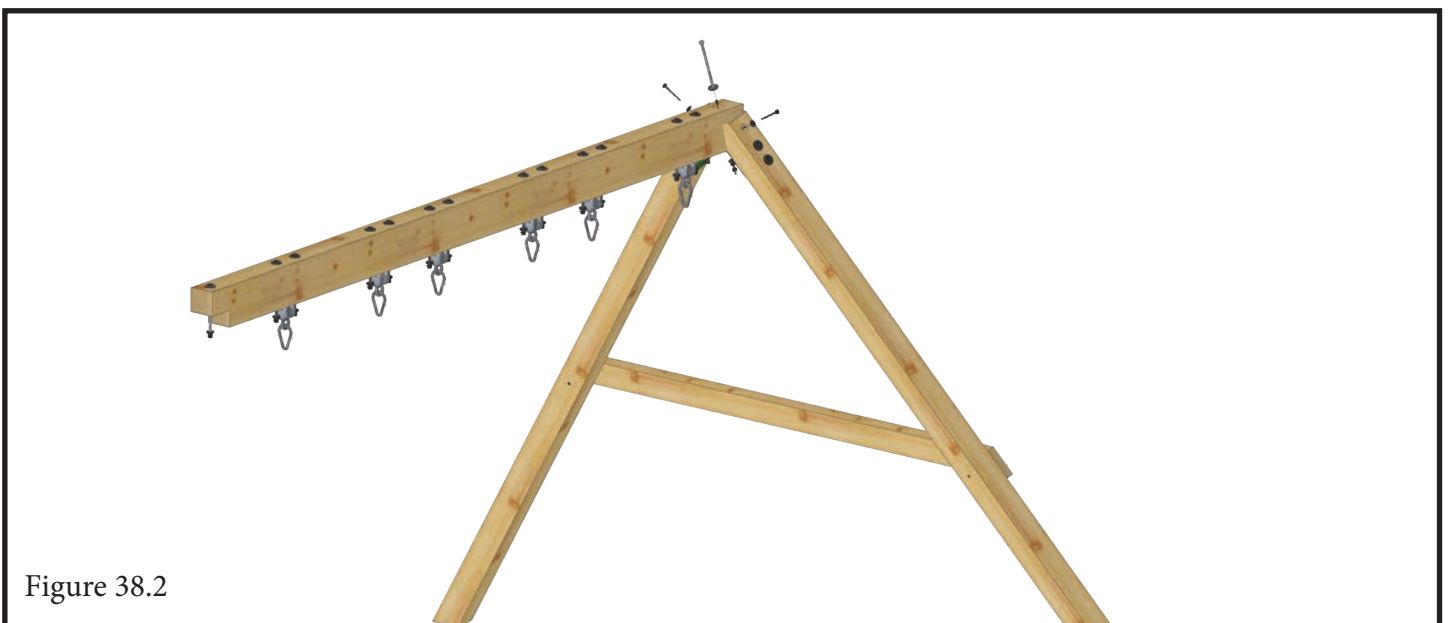

Figure 38.2



## Step Thirty-Nine: Slide & Swings

39.1 Fasten Swing Beam Assembly to Swing Beam Support with 3/8" x 7" Carriage Bolt with 1/2 Washer. Add 3/8" Washer, Lock Washer, and Nut. Tighten.

39.2 Fasten the slide to the play set deck with (3) 2" Pan Head Screws.

39.3 Fasten the swings to the spring clips at desired height on the chain.

